

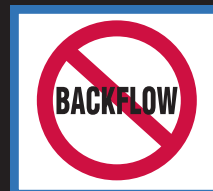

# STOP BACKFLOW NEWS!

Case Histories  
and  
Solutions



[watts.com](http://watts.com)

**WATTS**<sup>®</sup>

# Protection and Conservation of Safe Drinking Water

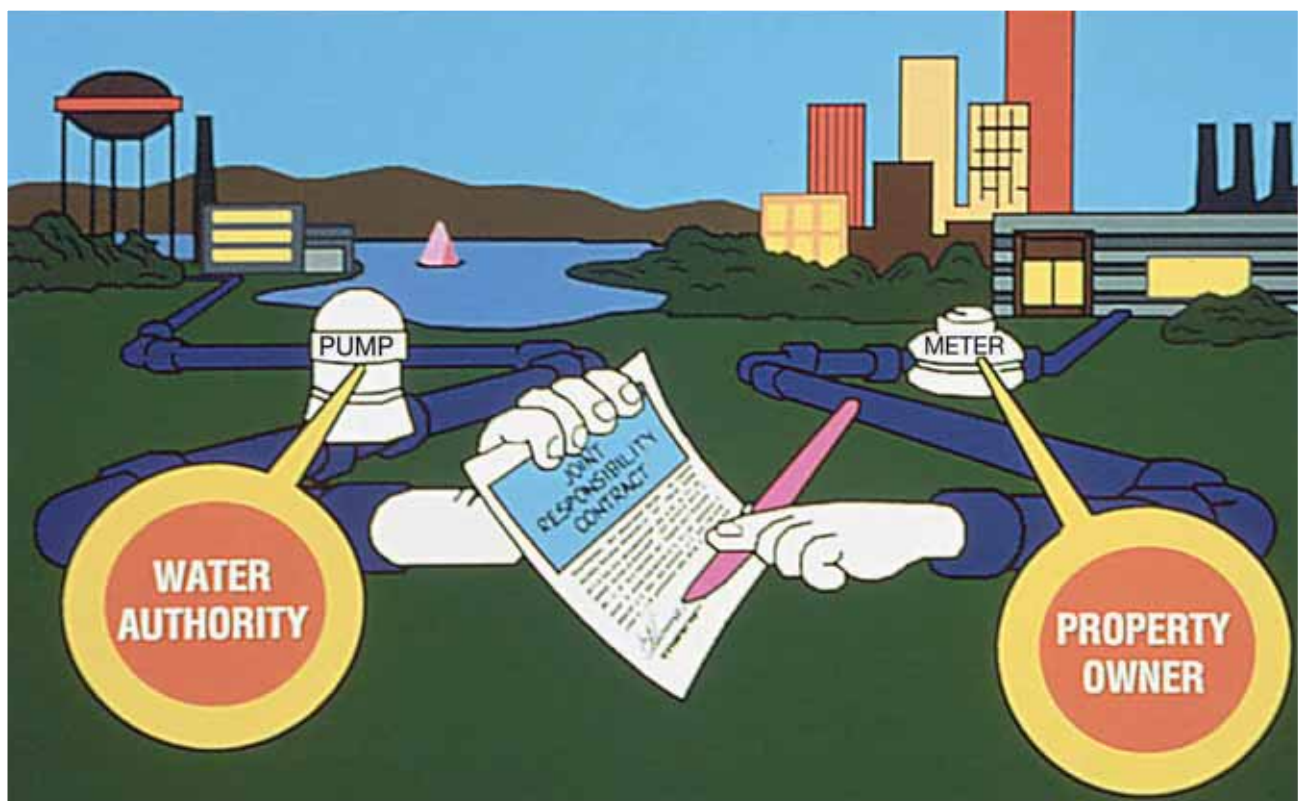

## **CAN BE HAZARDOUS!**

Consumers turn their faucets on and what they believe to be “safe drinking water” is immediately available, pure and plentiful. They assume the water is safe simply because no one has warned them otherwise.

“Safe drinking water” is Federally mandated and regulated by the Environmental Protection Agency. As a professional body, and under these mandates, the water utility is responsible for ensuring overall protection of safe drinking water under all foreseeable circumstances.

However, despite these strict regulations, extremely dangerous situations continue to occur when backflow contaminants are inadvertently allowed to enter our safe drinking water supplies!

The purpose of this booklet is to provide an understanding of how far-reaching and critical backflow contamination problems are and to urge the development of the most effective backflow prevention programs possible. To illustrate this, we have compiled a number of case histories - true accounts of hazardous, even fatal, situations when ineffective backflow prevention techniques were employed.

Backflow prevention is a long-term investment with ongoing requirements. All industry professionals are held to the higher standards and levels of responsibility necessary to protect that investment.

We are confident that when planning or updating a backflow prevention program, this publication will serve as a reminder of the professional commitment and responsibility necessary to provide the public with safe drinking water.

# Most Frequently Asked Questions Residential Backflow Prevention

## The combined efforts of cross-connection control (first line of defense) and containment (second line of defense).

**Q** I know that cross-connection control is important on industrial and commercial facilities, but is it necessary on residential connections? Is there really a risk?

**A** Cross-connection control is important no matter what type of service is involved. Industrial cross-connection control programs have been used for years. Historically, water purveyors have recognized the potential risk of high-hazard industrial connections in their systems and have taken an active roll in protecting the public water supply (primary system) from them. The potential risk from residential connections has been, for the most part, overlooked, even though some of the most serious cases of backflow originated at a residence. Chlordane was siphoned through a hose at a residence in Roanoke, Virginia, contaminating the water supply of an entire neighborhood. The cost to the water purveyor to replace water mains, valves, meters, service lines, water heaters, ice makers, and other plumbing was about \$200,000. In addition, lawsuits totalling several million dollars were filed. Since these suits were settled out of court by the water purveyor and the exterminator, no records are available on the actual amount paid, but it was probably considerable.

**Q** What do you mean by "second line of defense?"

**A** We call containment at the service connection using a dual check backflow preventer the "second line of defense" because it is intended as a backup to the plumbing cross-connection control program which controls backflow at the cross-connection itself. It might be compared to the safety latch on an automobile door: both would have to fail simultaneously before the door could open unintentionally.

**Q** Is the second-line-of-defense concept limited to residential systems?

**A** No, the principle must be applied to all systems, although the backup for high hazard facilities would require the use of a device that was designed for such installations, such as the reduced pressure zone backflow preventer. The dual check backflow preventer simply was not developed for use in high-hazard industrial applications. You wouldn't put a residential deadbolt on the door to the bank vault, would you?

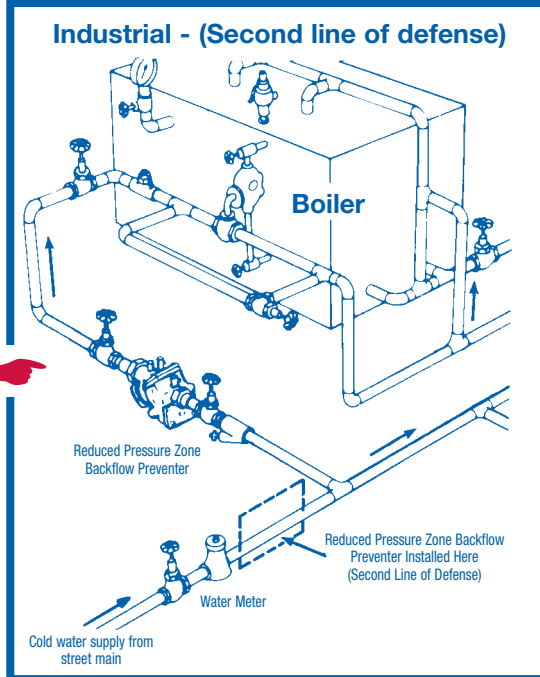
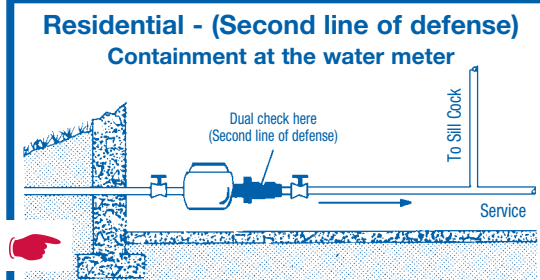
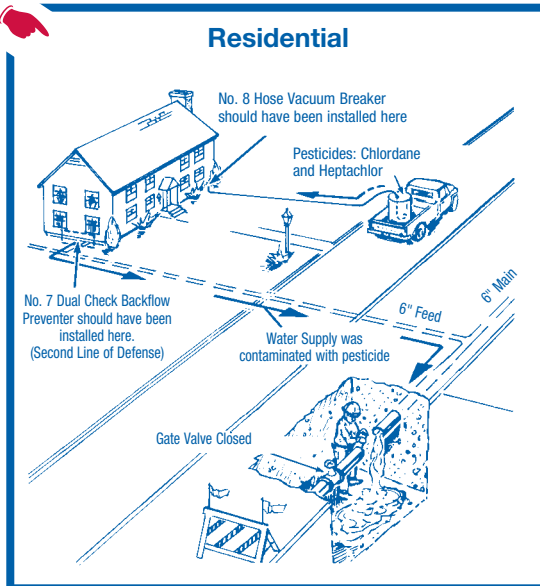

**Q** If plumbing codes require backflow protection at the cross-connection, why is a second line of defense needed?

**A** There are several reasons: The first is that plumbing codes, like other rules and regulations, are not always adequately enforced. The second, and by far the most compelling reason, is that the day after the certificate of occupancy is issued, plumbing becomes subject to unauthorized changes. Economic factors motivate homeowners to do-it-yourself plumbing. The bottom line is the cost of a competent plumber versus the savings when the homeowner does it himself. Generally, the homeowner is not only ignorant of the plumbing code requirements, he is totally unaware of the dangers of cross-connection and backflow. Finally, the installation of a dual check backflow preventer at the service connection divorces the public water supply from the domestic water supply and establishes jurisdictional authority and responsibility between the public water supply and domestic water system.

**Q** What types of water system protection are required in a residence?

**A** Plumbing codes are very specific here. They require backflow protection by cross-connection control and many important safety devices as follows:

1. Air gaps built into sink, tub, and basin faucets.
2. Anti-siphon type ballcocks in water closets (toilets).
3. Vacuum breakers on hose bibbs and sill cocks.
4. Backflow preventers or vacuum breakers on lawn sprinklers.
5. Backflow preventers on supply lines to boilers or other equipment containing non-potable fluids and cross-connected to the potable water system.

Because some local authorities modify existing national codes, certain areas require backflow protection on the following as well:

1. Residential swimming pools, hot tubs, and spas.
2. Residential solar heating systems.
3. Private wells and other auxiliary water supplies.

Most homeowners do not know they alone are responsible for the safety of domestic water system. It is up to the water purveyor to inform him.



**Q** Is the water purveyor responsible for enforcing the plumbing code?

**A** No, but the water purveyor **is responsible for protecting the public water supply**. That responsibility may include taking secondary measures beyond the plumbing code requirements, such as installing backflow prevention devices at residential connections to ensure that contaminated water does not enter the distribution system at one point, only to be served to another consumer down the line. Generally, the water purveyor's responsibility ends at the service-connection to the consumer's water system. However, since the need for this added protection is relatively new (past 15 years) many premises exist that must be retrofitted or brought up to today's standard. Therefore, the water purveyor must require the owner to provide proof of compliance with the current plumbing code and install a containment control device at each service or meter. The minimum standard of performance must be met before being tied into the system.

**Q** If you are going to install a dual check at the service connection, why not go ahead and install a more stringent device, such as the intermediate atmospheric vent backflow preventer or the reduced pressure zone device?

**A** If that idea had merit, the water industry would already have adopted it. The fact is, the industry made repeated requests to backflow preventer manufacturers to produce a compact, economical device that could be installed in the meter box as a second line of defense for the community water system. The dual check is a direct result of those requests. It is the only practical device for large-scale residential programs and it is designed to be installed with the meter, including in the meter box, for new or retrofit installations. One could equate the use of a dual check to the installation of a deadbolt on the front door: it provides better protection than a single lock in the handle, but it certainly doesn't provide the protection of a full scale electronic security system-nor does it cost as much to install and maintain.

**Q** Even so, suppose I decided to use the intermediate atmospheric vent backflow preventer or a reduced pressure zone device at the meter as the second line of defense, could it be installed in the box with the meter?

**A** Positively not, because meter boxes are subject to flooding. Each of these devices has an air-intake valve that would create a cross-connection the instant it became submerged. You could be creating a more dangerous situation than having no protection at all. The air-intake valves must be installed above ground, and they must be protected from freezing and vandalism. While these devices meet specific needs in the industry, they simply aren't practical for meter box installation.

**Q** I understand the dual check is limited by national standards to one-inch size. Suppose a residence had a service connection larger than one inch-what type of device would be practical?

**A** This would be an unusual situation, but a larger size double check valve backflow preventer could be installed in lieu of the dual check.

**Q** Speaking of national standards, what standards does the dual check meet?

**A** The dual check meets the ANSI/ASSE Standard 1024. Generally speaking, most standards address the performance and construction requirements including the quality of materials and workmanship - the quality of the bronze, stainless steel, plastic and rubber parts, and the spring tension, tolerance and tightness.

**Q** Do standards ensure reliability?

**A** No, all water works equipment requires a maintenance program. The more sophisticated devices-the reduced pressure zone backflow preventer, the double check valve backflow preventer, and the pressure vacuum breaker-all have something in common with the dual check: we know that after we test a sophisticated device a year will generally go by before we test it again. During that time, we trust we are protected. This trust is being hedged, however, with the knowledge that the device is manufactured to national standards and will, in all probability, prevent anyone from getting hurt. The story is the same with the dual check. The most significant difference here is that we know the dual check is not installed as a primary device, but as a backup, a sort of insurance policy against a residence not being or not becoming in full compliance with the plumbing code.

**Q** You mentioned testing. What are the major utilities doing about testing the dual check backflow preventer?

**A** For the most part, they are using selective spot-testing; a few are using 100 percent annual testing. All are testing at the time the meter is serviced or upon change of ownership.

**Q** How can a water purveyor gain confidence in a dual check that is designed for selective spot-testing?

**A** By experience. All backflow preventers, like other mechanical devices, are depended upon to work for a reasonable period of time after installation. Assuming the water purveyor removes a certain percentage of the devices on a selected grid of his distribution system, he will be able to determine if the devices are performing as intended and are suitable for extended service, or if his water conditions dictate the need for extensive maintenance or replacement. He can then make adjustments to his spot-testing procedures to ensure even higher reliability.

## Double Check Valve Backflow Preventer

Series 007  
Sizes: 1/2" - 3"

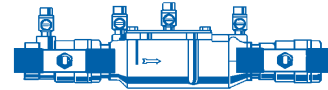

Series 709  
Sizes: 2 1/2" - 10"

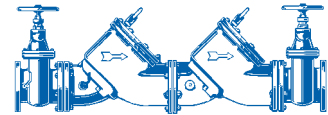

## Dual Check Backflow Preventer

No. 7  
Sizes: 3/8" - 1"



**Q** Is spot-testing adequate?

**A** Selective spot-testing is the mainstay method of quality control used in every industry in the world today, including the potable water supply industry. Clearly, spot-testing is nothing new to the water industry. It is used regularly to test meter accuracy, flow rates, and system pressure. In fact, spot-testing is used to ensure that the water is within the bacteriological and chemical limits established by EPA. The Safe Drinking Water Act requires that random samples of water be sent to certified labs. Using this method to test dual checks not only makes good economic sense, it can often provide additional valuable information to the water purveyor regarding the overall condition of his distribution system.

**Q** If spot-testing is adequate, why are all reduced pressure zone devices tested annually?

**A** Unlike the dual check, RPZs are intended for use in high-hazard installations and are considered the first line of defense. Interestingly, the air gap, purported to be the ultimate in cross-connection control, is assumed to remain in place and function indefinitely, since no periodic reports on inspections are maintained on these installations, even though defeating an air gap by adding an extension is a very simple and commonplace procedure. The selection, maintenance, and testing of every backflow prevention device demands the use of sound judgement, based on a reasonable assessment of the risk involved versus the cost of protection.

**Q** Regarding risks, is there a potential for liability from backflow into the mains when the source is beyond the jurisdictional authority of the water purveyor?

**A** Most definitely. All purveyors connect the public water supply of the utility to the domestic water systems of the consumer. Purveyors must require domestic water systems to comply with state and local plumbing codes (the first line of defense), but experience teaches that this is not always the case. Accordingly, we have a bonafide risk of contamination. The concern over potential liability is intensified by the Insurance Crisis in America and the fact that most utilities can no longer purchase liability insurance. Because we can not assume that 100 percent of the consumers will comply with the plumbing code, there is no alternative but to take additional measures to protect the public water supply. **That's where the dual check comes in. A second line of defense and establishes jurisdictional authority.** Economical, dependable, suitable for installation in the meter box, and a lot better than the millions of unprotected services in the country today!

**Q** Is there a possibility the utility would be held liable for an incident that occurred in spite of an active second line of defense program?

**A** That's highly unlikely. Certain not if the contamination was contained in the domestic water system; highly unlikely if some of it got into the public water supply. There would be a legal defense for an ongoing backup program, even if it failed. There would be no defense for a nonexistent program.

**Q** What about thermal expansion? Doesn't the dual check create a closed system?

**A** A backflow preventer like any other checking device installed at the service connection creates a closed domestic water system. The water purveyor has the right and duty to contain all domestic water systems that, in his judgement, represents a threat or a potential threat to his public water supply. Prior to closing the domestic water system by installing a dual check backflow preventer, however, the purveyor has a responsibility to notify the consumer and the plumbing official, in writing, of his intent to do so. The consumer must then make provision for any resulting thermal expansion through the installation of a Watts Gov. 80 anti-siphon ball cock and relief valve, auxiliary pressure relief valve, or a thermal expansion tank.

**Q** Could the water purveyor make his own provision for thermal expansion?

**A** No. The control of thermal expansion is plumbing by nature. All domestic water systems that are in compliance with the plumbing code would have provisions built in. It makes more sense for water purveyors to get on with protection of the public

water supply and advise the owner or his designated agent to comply with the plumbing code.

**Q** Is the residential containment method of water system protection being favorably accepted, and can you elaborate on the actual operations in some of the major cities' programs?

**A** Yes. "Containment" or the "second line of defense" has been very favorably accepted in the U.S.A. and Canada. Recently, major cities have reported very successful operations of their backflow programs. Since these communities are extending backflow prevention to include residential homes, the water supply is now safe. The actual operations or mechanics of backflow prevention is based on the following:

1. A valve required on all new residential homes located at the meter.
2. Existing homes are retrofit during meter change out programs or at the time of change of ownership.
3. All customers are required to provide a certificate of compliance with the plumbing code. Residential homeowners utilize a short, simple, self certification form. (A sample short form is available, contact your representative listed on back page.)

Rather than specifically call for compliance with cross-connection control, the form is designed to cover water system safety in homes. Included is a check off for the T&P valves on water heaters anti-siphon ball cocks, thermal expansion relief devices, etc. Plumbing code is clear that the owner or his agent is responsible for safety of his plumbing system. It would not be prudent for the public water supplier to require anything less than the minimum legal requirements. No reasonable person would conclude otherwise.

**Q** Can the dual check be adapted to existing meter installations?

**A** Yes, Watts offers models with meter threads, pipe threads, male or female threads, or combinations, on one or both ends. Unions are also available on one or both ends. In addition, Watts also offers water meter station standardization packaging that is designed to bring existing and

new meter installations up to today's higher standards. The custom-design meter setters enable water utilities to provide backflow protection, pressure regulation, or water hammer shock arrest in compact, efficient modular packages. Efficient meter reseters can provide similar protection for existing meters without requiring plumbing changes.

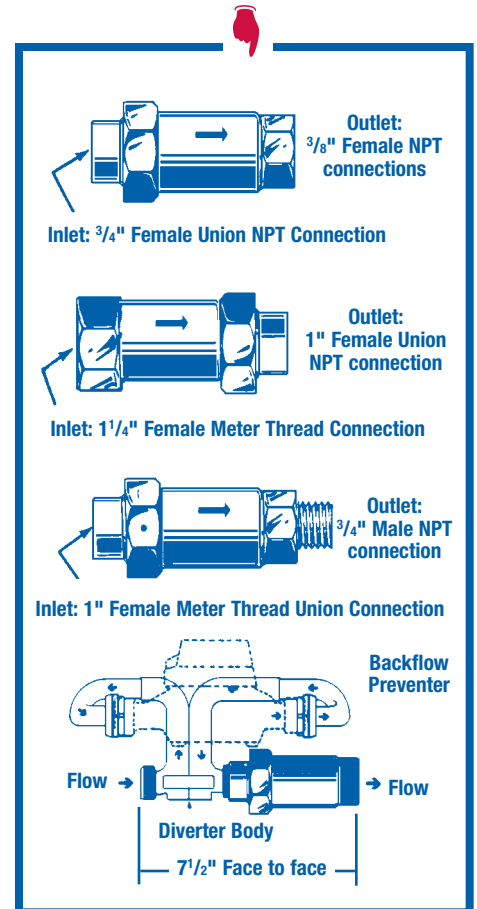

**Q** How much does it cost to establish a "second line of defense" program utilizing dual check backflow preventers?

**A** The cost, of course, will vary depending on the type of installation. However, compared to the cost of a serious backflow incident, a "second line of defense" program is relatively inexpensive. In addition to the cost of replacement or repair when a public water supply is contaminated, courts may impose judgements in favor of injured parties and the cost can skyrocket along with bad publicity. How can a utility afford NOT to take extra precautions to protect the public water system, its customers, and its good reputation?

Send for our folder F-BDL that explains the importance of jurisdictional authority, total containment and several other important subjects that every individual in the water industry should be informed about.

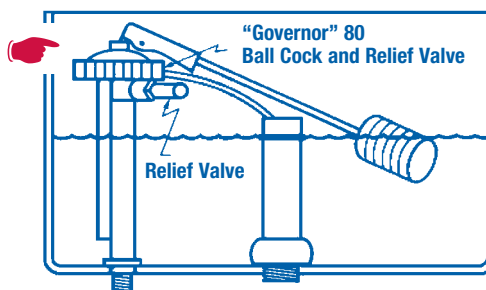

**Typical Water Closet**  
Send for Folder F-80

## May 1973

### Backflow Case - insecticide chlordane

This one happened in New Jersey and was reported in the New Jersey AWWA publication, PIPELINE.

A breakdown in a 24" water distribution main on May 16, 1973, triggered an event which endangered residents of the Morganville and Wickatunk section of Marlboro Township who receive water service from the Marlboro Township Municipal Utilities Authority.

An exterminating contractor created an illegal cross-connection by diluting a quantity of the highly toxic insecticide, CHLORDANE, by means of a submerged garden hose into a drum of this material. The main break, which occurred during this operation, caused a negative pressure in the distribution system resulting in the siphonage of the entire contents of the drum, through the house service connection and into the distribution system.

This incident exemplifies the danger of illegal cross-connections, and indicates the need for the provision of check valves or vacuum breakers on all outside hose bibs.

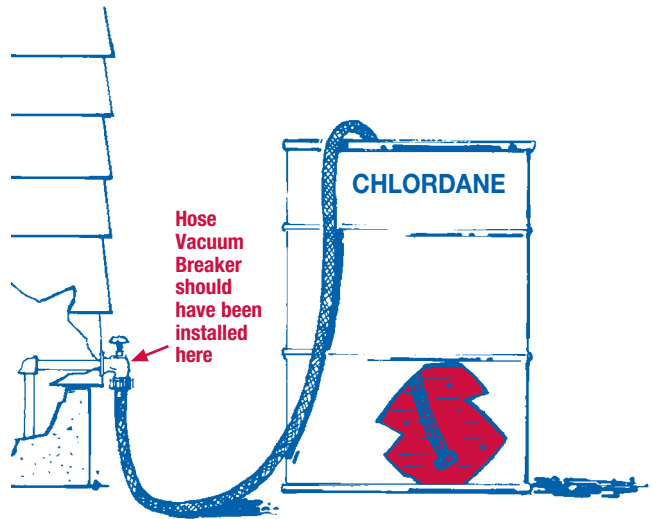

Reprinted from: Aquarius

## February 1974

### Poultry Farm cross-connections - virus vaccine

The following are details regarding an article which appeared in the February, 1974 issue of "Poultry Digest" regarding cross-connections in the Poultry Industry.

The feeding of live virus vaccine into potable water to immunize poultry against disease is a popular practice, but one that creates a serious cross-connection. Significantly, the Food and Drug Administration published a list of twenty-two live virus vaccines used to immunize cattle, swine, and poultry; and most of these are pathogenic to man.

There are over 57,000 poultry farms in the United States. Last year a cross-connection survey was conducted at twenty-six farms located in five counties of a southern state... resulting in the discovery of 13,000 cross-connections!

Therefore, in order to prevent the possibility of the virus flowing back into the drinking water supply, it is essential that backflow prevention devices be installed.

## December 1974

### Backflow Case Fast Food Chain Restaurant - boiler water chemical

On December 7, 1974, in a moderate size city in North Carolina, a major fast food chain restaurant received complaints of a bitter taste in the soft drinks they were selling. Over 300 people were served soft drinks during the period in question.

The local water department traced the problem to a chemical in the water and determined this particular chemical was used to treat boiler water in a fertilizer plant, located one-half mile away from the restaurant. Investigation at the fertilizer plant revealed that a check valve on the supply line to the boiler was leaking and allowed the chemicals in the boiler to backflow into the street main supplying the restaurant.

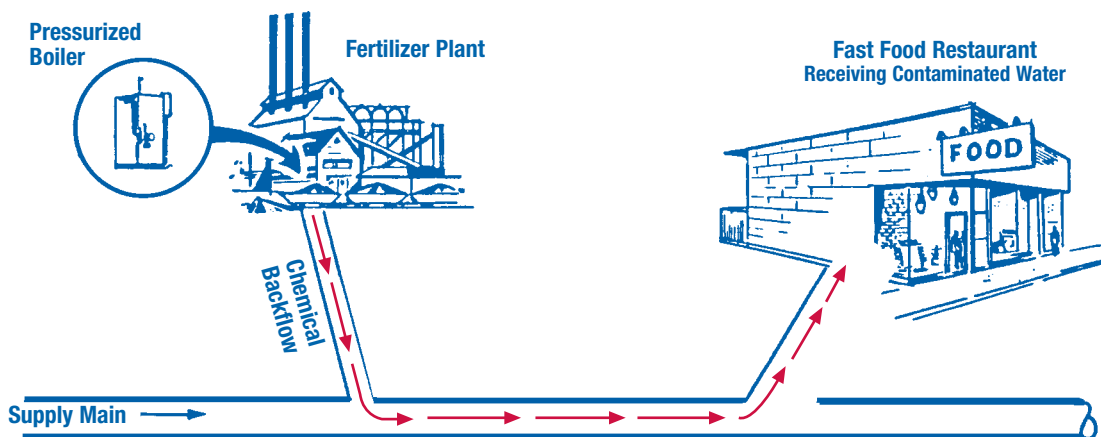

## **June 1974**

### **Backflow Case - Hynes Auditorium, Boston, MA - chromium from chilled water system.**

Tuesday morning, June 18, 1974, was typical of the ever changing Boston weather. A hot, humid day followed two days of periodic rain. It was uncomfortable for the thousands of registrants who thronged Boston's Hynes Memorial Auditorium for the 94th Annual AWWA Conference and Exposition.

Murmurs of "turn up the air conditioning" were soon followed by "check the air conditioning" as thousands of people noticed a yellow hue to the drinking water. The Boston Globe edition of June 21, 1974 described what happened that day. Chromium was added to the chilled water system by means of a manually operated shutoff valve. It was later determined that this shutoff was inadvertently left opened. A reverse flow condition occurred and resulted in the "yellow water" being distributed to drinking bubblers, soda fountains and coffee makers in the Auditorium. Tuesday night, handles were removed from the drinking fountains and the cafeteria water was closed down.

The problem was later corrected with the installation of a Watts Reduced Pressure Principle Backflow Preventer on the supply to the chemical treatment plant.

## **October 1974**

### **Backflow Case in Automotive Coating Plant - cleaning solvent**

On October 25, 1973, a backflow case was reported in a automobile coating shop located in an industrial mall in a city in Ontario, Canada.

This type of business is fairly popular in Canada where cars are driven into the shop to apply undercoating and preventive coating in trunks, under hoods, door panels, etc., to preserve the car metal. The mall was only partially filled with tenants and the undercoating plant was located in Unit No. 11. The next occupied unit was No. 21, leaving ten unoccupied areas in between.

In the pre-cleaning operation, hot and cold water was fed to a pump operating at approximately 75 lbs. with the discharge side of the pump connected to a gun-type spray nozzle. A hose was then connected from the pump into a solvent tank which supplied the solvent to the spray gun. On October 25, 1973, the pump was left on between cycles, and the pump pressure of 75 lbs. overcame the city supply pressure of 50 lbs. causing the cleaning solvent to backflow from the coating shop and into the supply main. A tenant in Unit No. 21, which was the next "occupied" unit within the mall, reported a bad taste in the water which eventually lead to the discovery of the backflow condition.

To correct the problem, it was recommended that Watts No. 9D Backflow Preventer with Intermediate Atmospheric Vent be installed on both the hot and cold supply lines to the pump and a Reduced Pressure Principle Backflow Preventer be installed at the meter. Also, a Watts No. 8 was attached to the hose bibb faucet.

Additionally, in order to clear the supply lines of the contaminant in the unoccupied building lines, it was necessary to drain the lines, after which they were steam cleaned to remove the chemicals. This is an excellent example in support of the statement that "backflow certainly costs more than the prevention."



## September 1974

### Backflow Case - New York City Office Building - chromates from air conditioning

The cause was a cross-connection between the potable water supply and the air conditioning system. A back-pressure backflow condition forced chromates into drinking water lines ultimately causing illness to twenty persons. This case is similar to the Hynes Auditorium, Boston, backflow case, where the same “yellow water” was distributed to fixtures. It is more similar to the St. Joseph’s College, Pa. case reported in August, 1970 when a maintenance man hooked a hose from a service sink to dislodge a blockage in the air conditioning system.

The threaded faucet in this particular case, for example, was not an actual cross-connection ... it was a potential cross-connection! It became a hazard when the hose was attached to admit make-up water. This is a typical example of how a potential hazard was converted to an actual hazard by means of human error. Ironically, if an inexpensive Hose Bibb Vacuum Breaker had been installed on the threaded faucet, this case never would have occurred!

## October 1978

### Backflow Case - U.S. Naval Ship - photographic developer

Another documented case of backflow, occurring on a U. S. Naval Ship, was reported recently in the Morbidity and Mortality Weekly Report, Volume 27, No. 28, issued by the Center for Disease Control of the U. S. Department of Health and Welfare. The case concerned itself with a “makeshift” cross-connection consisting of a rubber hose which led from a 40-gallon tank used to mix photo developer (hydroquinone) to the ship’s potable water system. Five hundred and forty four crewmen aboard this large Naval vessel developed a gastrointestinal disease as a result of this cross-connection. Details are quoted as follows:

“Between July 21 - 31, 1977, five hundred and forty four crewmen aboard a large U. S. Naval vessel developed gastrointestinal disease. The illness was characterized by the acute onset of nausea, vomiting, abdominal cramps, and diarrhea generally resolving within 12-36 hours. On the morning of July 28, when reporting for their required morning roll call, 301 men from 4 units with high attack rates were interviewed. Fifty-five of these individuals met the definition of a case (vomiting during the last 7 days), leaving 246 controls. Interview responses indicated that cases were significantly more likely to have drunk water while the ship was at sea, implicating the ship’s water system.”

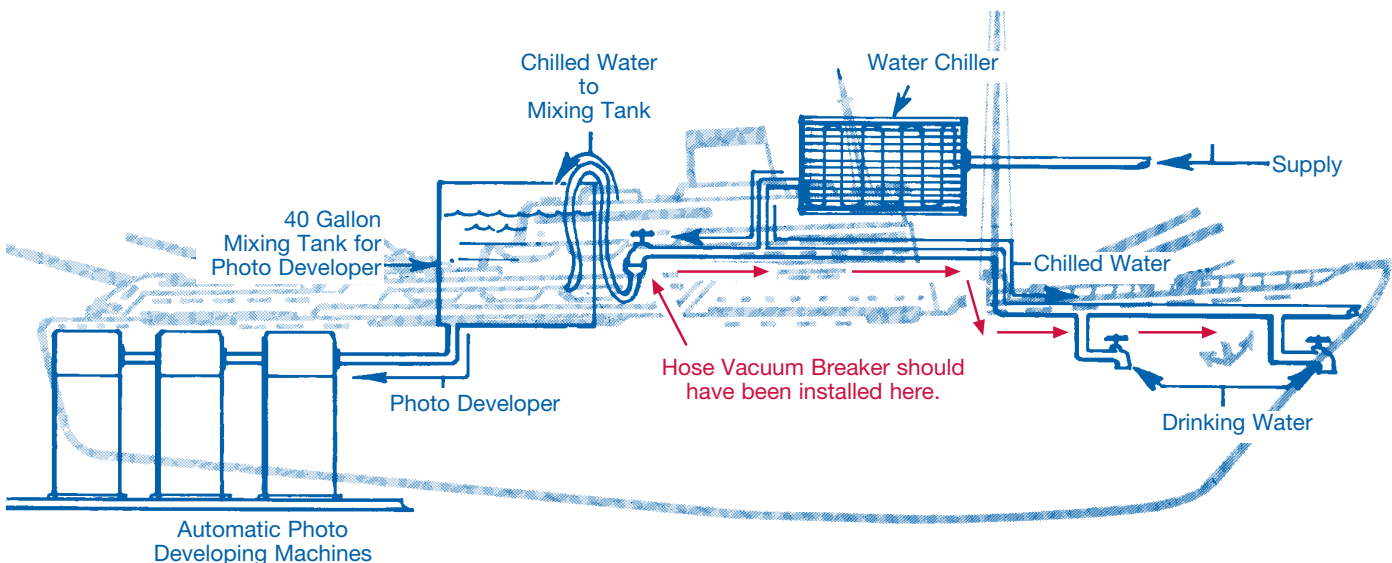



## October 1979

### Another Pesticide Backsiphonage Case - pesticide

Approximately three gallons of chlordane, a highly toxic insecticide, was sucked (backsiphonage) into the water system of a residential area of a good size eastern city in October 1979. Residents complained that the “water looked milky, felt greasy, foamed and smelled,” as one woman described it, “like a combination of kerosene and Black Flag pesticide.”

The problem developed October 12 while water department personnel were repairing a water line. An exterminator, meanwhile, was treating a nearby home with chlordane for termites. The workmen for the exterminating company left one end of a hose connected to a water tap and left the other end in a barrel of diluted pesticide. During the water service interruption, the solution was siphoned into the pipes from the barrel. This backsiphonage “accident” has followed precisely the same pattern as other such cases documented during the past few years.

The water department undertook an extensive program of flushing the mains and the possibility exists that some of the mains, the service lines, hot water heaters and appliances, will have to be replaced.

A water department employee said that the homes in the affected area, because of hilly terrain, are particularly susceptible to siphoning in the water lines and were built 17 to 20 years ago before the city building code required vacuum breakers or backflow valves in new construction.

This is another case where even though the backsiphonage condition existed in the street water mains, the reverse flow of the pesticide through the garden hose and resultant contamination of an entire neighborhood could have readily been prevented with the use of a Residential Dual Check Backflow Preventer or a Hose Connection Vacuum Breaker.

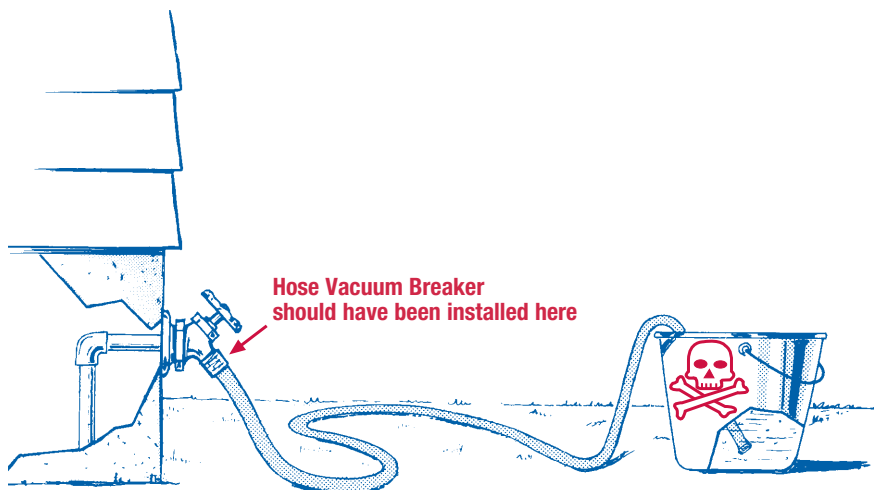

## October 1979

### Meat Contamination at Packing Plant - sewage water

A case of contamination of large quantities of meat occurred recently at the Swift & Company packing plant in Marshalltown, Iowa. The precise cause of the contamination is still under investigation; however, it is known that a great deal of pork was contaminated by waste water at this large packing plant. Several U. S. Department of Agricultural officials have commented that the impoundment of pork from this plant is one of the largest impoundments that they can recall.

As reported by the Times Republican, “because the wrong pipe was hooked -up to a newly drilled well at the Swift and Company plant here, some \$2,000,000 worth of pork has been contaminated by the waste water. The meat became contaminated when plant employees unwittingly sprayed contaminated water on hog carcasses and cuttings during the normal cleaning process”. As reported in the April 30th issue of Food Chemical News, “Food safety and quality service officials have concluded that there was a cross-connection of water lines between potable and non-potable water, causing sewage water from the kill floor and water used to deodorize rendering operations to get into the potable water line.”

The seriousness of the situation was such that once detected, the plant was shut down for an extended period of time while federal officials attempted to determine the exact cause of the contamination, monitor decontamination and sterilization procedures, and determine what specifically will be done with the \$2,000,000 of pork in process in the plant at the time of the occurrence.

Swift and Company has reportedly spent over \$3,000,000 already as a result of the problem, in addition to the fact that 200 people were unemployed for extended periods of time while the situation was cleaned up.

The cost of effective cross-connection control cannot be overemphasized in light of this significant occurrence. The expense entailed in installing, testing and maintaining backflow hardware becomes insignificant when compared to the magnitude of the economic loss in situations such as this.

The bottom line is protection of potable water lines through effective use of cross-connection control devices.

## February 1979

### Backpressure Backflow Incident - Seattle. Washington Car Wash

#### THE INCIDENT

Monday, February 12, 1979, was typical of city holidays, with skeleton office and laboratory staff, and field crews sufficient for emergency response. At approximately 9:00 a.m., the Seattle Water Quality Laboratory received a call from a resident of a mobile home park reporting that the water coming from the tap was grey-green in color and felt “slippery.” Almost immediately, another party from the same park reported the water as appearing “muddy.” The problem was assumed to be a local condition within the park, since no other complaints from this service area had been received that morning, and “dirty water” complaints usually involve more than one customer’s service. Both customers were advised to flush their cold water taps and call back if the condition persisted.

An hour later, the first caller came into the laboratory with a sample of his tap water, confirming the physical appearance reported earlier. Preliminary laboratory tests indicated contamination with what appeared to be a detergent solution. While the laboratory tests were being conducted, additional “soapy water” calls began coming in, this time from outside the mobile home park. One caller remarked that the water was black and had the odor of garbage.

The Department’s Assistant Director of Water Quality, when advised of these developments, immediately contacted the operations dispatcher with instructions for the emergency field crew to initiate flushing of specific hydrants in the affected area, although at this point neither the scope nor the source of the problem had been determined. He also left for the area in a radio-equipped car to investigate the source of the problem and direct the progress of the flushing crews. The fact of the soapy water immediately signaled car wash or laundry, and upon arrival in the area, the source was readily identified as a large car wash located on Aurora Avenue North. The proprietor of the car wash was extremely cooperative in first admitting to, and then explaining, the circumstances which caused the backflow condition, thus saving valuable time in trying to locate the source and identify the contaminant. Once the source was located, it was a relatively straightforward matter to track the path of the contaminated slug by the location of customers’ complaints, request additional flushing crews, and direct the flushing to intercept and limit the scope of the contamination.

Once the “soapy water problem” was determined to be more widespread than initially thought, consideration was given to public notification. The State and City Health Departments were first apprised of the situation, and then a statement for release to the news media was drafted. Approval for the statement was given by the Superintendent of Water, and a total of six radio and television stations were contacted, with one television station interviewing the Water Quality Engineer and another filming the flushing crew.

The flushing crews worked well into the evening hours until strong chlorine residuals at each hydrant flushed indicated the problem had been abated.

#### THE CROSS-CONNECTION

The circumstances leading up to the incident just described is an object lesson for all water utilities. Briefly, the following occurred:

- On Saturday, February 10, 1979, about 2:00 p.m., a pump broke down at the car wash. This is a high pressure pump which takes its suction from the tank containing the reclaimed wash and rinse water and pumps (recycles) it into the initial (scrubber) cycle of the car wash. This cycle is not normally connected to the station’s potable water supply.

- After the pump broke down, the piping in the rinse cycle (which operates with city water pressure) was connected to the scrubber cycle piping by means of a two-inch hose. This arrangement allowed the car wash to remain in operation.

- On Monday, February 12, 1979, at 8:00 a.m., the owner came into the station and examined the pump. The pump was repaired almost immediately and turned on. The two-inch hose (cross-connection) between the scrubber and rinse cycle plumbing was still connected. However, the employees at the car wash did not realize that a quantity of the reclaimed wash/rinse water had been forced into the twelve-inch water main in Aurora Avenue North through the cross-connection and the stations' two-inch service connection when the pump was turned back on.

-Sometime later (the owner said 8:30 a.m.), an employee went into the stations' restroom and noticed brown soapy water in the toilet bowl after it was flushed. The cross-connection was immediately realized and the two-inch hose removed.

## THE OUTCOME

Various samples for laboratory analysis were taken during the course of the incident. In addition to the previously mentioned tests which characterized the problem as a detergent, bacteriological samples were analyzed for total coliform and Standard Plate Count. All were within normal limits. Special samples collected following the incident for organic analysis were submitted the U.S. Environmental Protection Agency laboratory in Seattle. These laboratory results also were within normal limits. Two customers in the contaminated area reported illnesses after drinking the water, but investigations by the Seattle-King County Health Department epidemiologist were unable to authenticate either occurrence. Within twenty-four hours of the incident, the owner of the car wash had installed a two-inch reduced pressure backflow prevention device on his water service, and within one week, all car washes using a wash water reclaim system were notified of the State requirement for backflow protection.

### Schematic Piping Installation of Car Wash Showing Cross-Connection

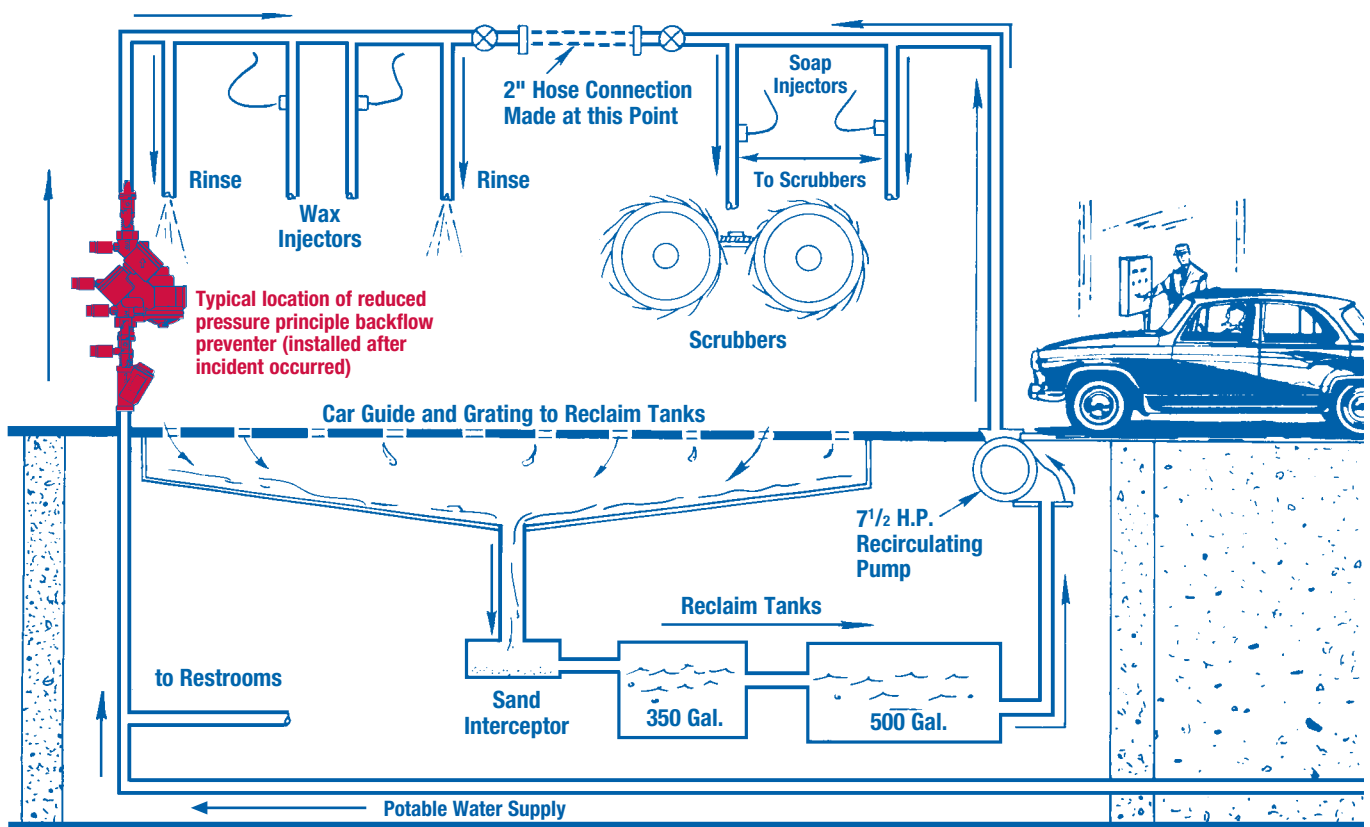



## March 1980

### Backpressure Backflow Incident - rust inhibitors, antioxidant chemicals

On Saturday, March 1, 1980, a large fire occurred two blocks away from a seven-story office building in downtown Manchester, N.H. On Sunday, March 2, the maintenance crew of the office building arrived to perform the weekly cleaning, and after drinking the water from the drinking fountains and sampling the coffee from the coffee machines, they noticed that the water smelled rubbery and had a strong bitter taste.

#### THE CROSS-CONNECTION

The neighborhood distribution system grid plans were examined and buildings most likely to have questionable or possible contaminants were checked first. A nearby radiator shop was found to have 200 gallons of antifreeze, soldering flux and related liquids contained within the building, together with many cross-connections. Samples of water found in this building were not similar to the contaminant samples taken from the seven-story building, however, the internal plumbing in this radiator repair shop was immediately required to be upgraded and backflow preventers added. Other potentially hazardous sites on the grid system were protected by backflow prevention devices at their service entrances.

The seven-story office building housed one of the latest solar heating systems in the northeastern United States, and accompanying it was a very complex plumbing and piping system. This presented a great challenge in attempting to determine if a cross-connection was present. Knowing the type of contaminant was helpful in attempting to determine the source of the cross-connection. Water pH levels of the building water and water pH samples taken at the water treatment plant were compared. This indicated that an injection of chemicals had taken place in the water system, and in all probability it had occurred within the seven-story building.

The Cross-Connection Control Inspectors traced each potable water line inside the seven-story building in an attempt to determine the source of the potential cross-connection. They were very fortunate in being able to locate a potable supply line that fed the make-up water to a 10,000 gallon hot water storage tank that was used for heat storage in the solar heating system. It did not have any backflow protection. As this storage tank pressure increased above the supply pressure due to thermal expansion, the potential for backpressure backflow was present. Normally this would not occur

because a boost pump in the main supply line would keep the supply pressure to the storage tank always greater than highest tank pressures. The addition of rust inhibiting chemicals to this storage tank greatly increased the degree of hazard of the liquid. Unfortunately, at the time that the fire took place on Saturday, the pressure in the mains was depleted to an unusually dangerously low point and low pressure cut-off switches simultaneously shut off the booster pumps in the building. This combination gave the boiler water, together with its chemical contaminants, the time to travel into the potable drinking water supply within the building. When pressure was reestablished in the mains and the booster pumps kicked in, contaminated water was delivered throughout the entire building.

#### THE OUTCOME

Backflow prevention devices were required to correct the internal deficiencies on the make-up supply and backflow units were also required at the service entrance to comply with the Manchester Water Works cross-connection Control containment regulation. The Manchester Plumbing Inspector and the head of the Manchester Health Department were contacted and shown the problems in an attempt to help others recognize the importance of the cross-connection control problems as it pertains to internal piping systems within buildings.

This incident again emphasizes the importance of providing backflow protection to boiler feed supply lines, make-up feeds, and hazardous storage tanks. The contaminant encountered in this Manchester cross-connection control incident was a result of rust inhibitors, antioxidant chemicals and defoamants being injected into the heat storage tanks. The mixture consisted of a 30% solution of sodium nitrate, 20% defoamant, 50% NABT and 20% sodium borate. Surely the addition of these chemicals to water creates a toxic substance that, if allowed to flow back into the potable water supply, creates a serious health hazard.

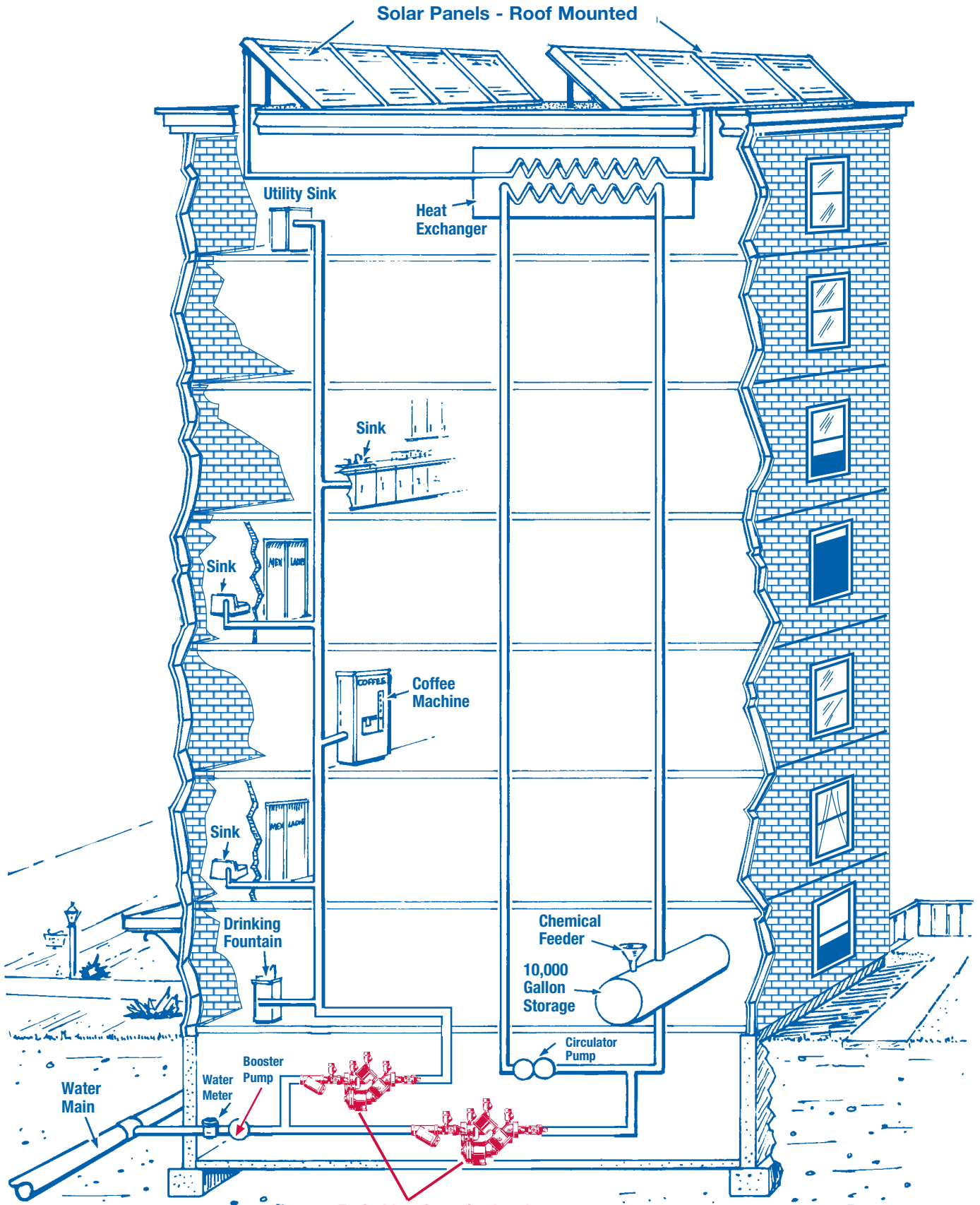

Typical locations of reduced pressure principle backflow preventers (installed after incident occurred).

## January 1981

### Backflow Case Fast Food Restaurant - sea water

On Thursday morning, January 29, 1981, a nationally renowned fast food restaurant located in Norfolk, Virginia, complained to the Water Department that all their drinks were being rejected by customers as tasting "salty." This included soda fountain beverages, coffee, orange juice, etc.

A check was then made with adjacent water customers which revealed that an additional salty water complaint had occurred simultaneously at a waterfront ship repair facility. Both the restaurant and the shipyard were being served from the same water main lateral which, in turn, came off the main distribution line. A cross-connection control inspection of the ship repair facility was promptly conducted and revealed the following:

- 1) The backflow preventer installed on the service line to the shipyard had frozen and burst earlier in the winter. It had been removed and was replaced by a sleeve in order to maintain the water supply to the shipyard. All protection against backflow was thereby eliminated!
- 2) The shipyard fire protection system consisted of high-pressure sea water maintained by both electric and diesel driven pumps.
- 3) The pumps were primed through the use of a city water line which was directly connected to the high pressure fire system.

With the priming line left open and the first service pumps maintaining high pressure in the fire service lines, raw salt water was being pumped under positive backpressure through the sleeve into the public water distribution system.

To correct the problem, the city water prime line to the pumps was removed and a new backflow preventer was promptly installed at the service line in place of the sleeve. Heat tape was wrapped around the backflow preventer to prevent future freeze-ups.

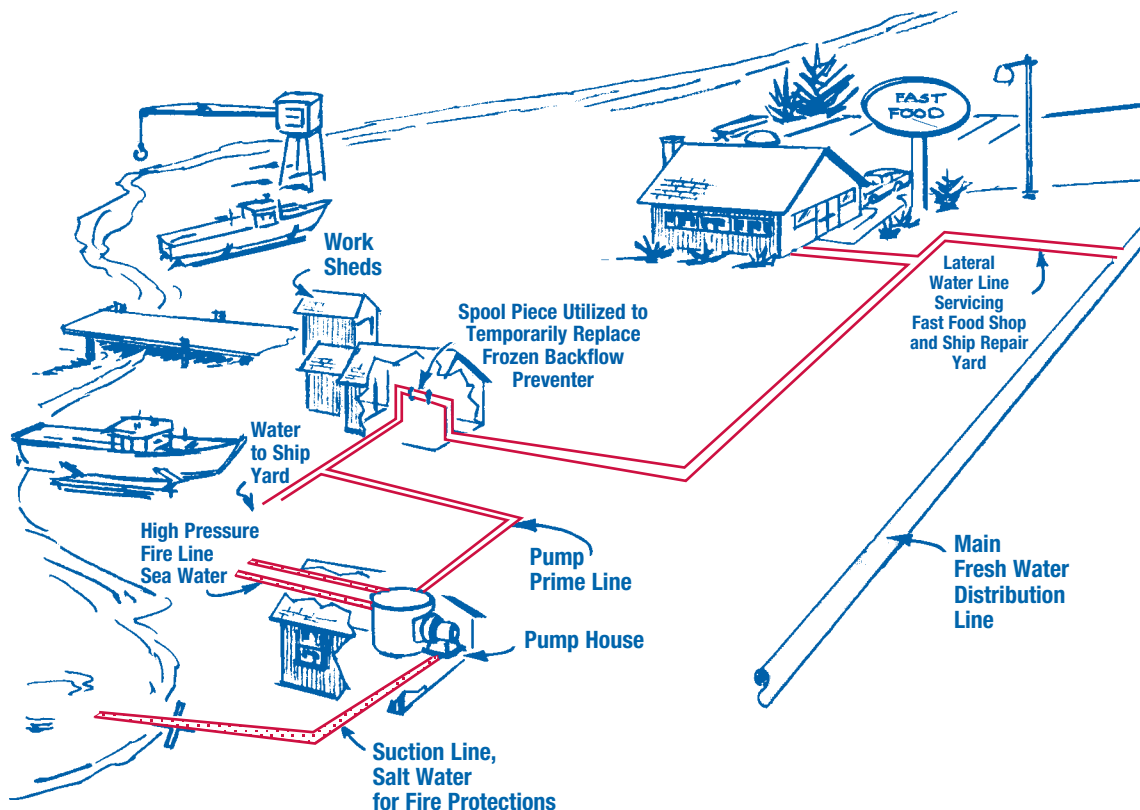



**July 1981**

## **Contaminated Water Supply in Allegheny County - insecticides chlordane and heptachlor**

The Allegheny County Housing Authority spent approximately \$300,000 to replace the plumbing piping, both inside and outside, of a large Allegheny County Housing Authority development in Robinson Township. Groveton Village is a neighborhood consisting of twenty-three buildings, each consisting of four apartments, owned and operated by the Allegheny County Housing Authority. The piping was made unserviceable as a result of chemical contamination of the drinking water as a direct result of insecticide getting into the potable water supply. Chemical tests of the water showed that the chemicals, chlordane and heptachlor, which are toxic and which have been banned since 1976 for agricultural use, entered the potable water supply as a result of a cross-connection.

The insecticide entered the water supply system while an exterminating company was applying it as a preventative measure against termites. A pesticide contractor was mixing the chemicals, chlordane and heptachlor, in a tank truck with water from a garden hose from one of the apartments. The end of the hose was submerged in the chemicals, at the same time the water to the area was being shut off and the lines were being drained. A plumber cut into a six inch main line to put in a gate valve. When he cut the pipe and the water started to drain, this set up a backsiphonage condition. The drainage point was downstream of the tank truck. Consequently, the chemicals were siphoned out of the truck and fed into the system. It is not known what quantity was involved.

The services to seventy-five apartments housing about three hundred people were contaminated. Repeated efforts to clean and flush the lines were not satisfactory and it was finally decided to replace the water line and all of the plumbing that was affected. There are no reports of illness. However, residents of the Housing Authority were told not to use any tap water for any purpose, and they were given water that was trucked into the area by volunteer fire department personnel. They were without water for 27 days.

The township contacted the Pennsylvania State Representatives from Allegheny and Washington Counties concerning the introduction of legislation to prevent this problem from happening again.

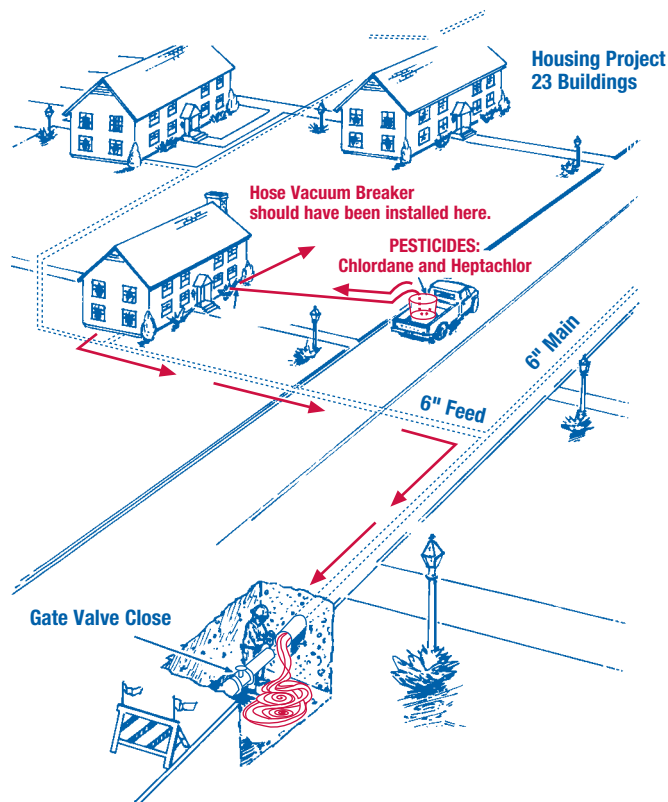

## March 1982

### Common Fireline Cross-connection - Oregon Health Division

#### From Pipeline News

The manager of a plywood mill requested the county health department to sample the drinking water of the mill after receiving complaints from employees about its "milky white" appearance. Working with the city water department, the county sanitarian collected samples from the mill and another location in the city. Though the mill receives city water (surface source with full treatment), water at the mill showed a zero chlorine residual. In contrast, a nearby location in town had clear water with a free chlorine residual of 0.3 mg/l.

The following day, an unusually large number of employees stayed home from work, with a majority reporting similar symptoms of nausea and severe diarrhea. Bacteriological sample results were reported the day after: five tubes positive and fecal coliform present in the mill's water sample, while the sample from the nearby location in town was negative.

In addition to the city water supply, the mill also draws water from an adjacent river to supply its fire system. Booster pumps maintain the fire system pressure at about 125 psi. The water from the city enters the mill at about 70 psi.

The mill's maintenance personnel examined the piping system for a cross-connection. Their investigation was hampered by incomplete and inexact piping system drawings. They located three interconnections between the fire and potable water systems with the gate valves open. Further investigation found that the mill's recent water use had been exceptionally low; 10 cubic feet per month instead of the 7,000 - 9,000 cubic feet used by comparable mills.

The conclusion was reached that the mill employees had been drinking untreated river water via a cross-connection.

A single check valve was located at the mill's connection to the city. It is assumed this prevented contaminated river water from entering the city's mains.

Because of the difficulty in locating all possible cross-connections, the mill decided to install all new potable water lines. **An approved reduced pressure principle backflow prevention assembly was installed on the water connection to the city system.**

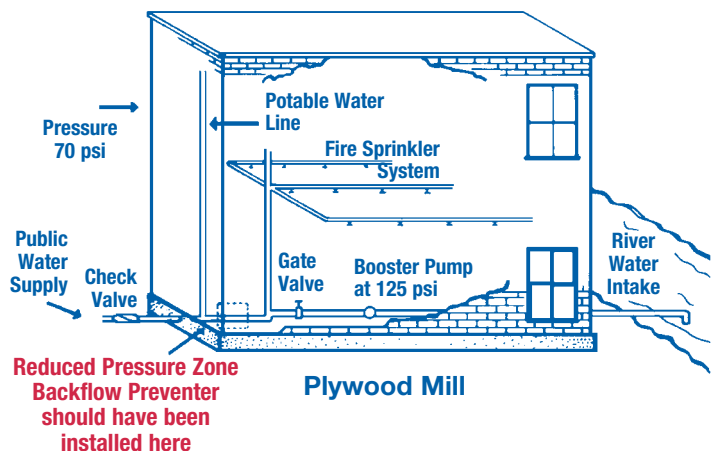

## July 1982

### Backpressure Backflow Incident - North Andover, MA

#### By Chris Woodward Eagle-Tribune Writer

NORTH ANDOVER - Western Electric Co.'s 9,000 employees return from a week's vacation tomorrow with assurances that drinking water contaminated while they were away has been cleaned up.

"We ran over 500 tests and found no traces of any substance," John Connors, spokesman for the company, said Friday. Further tests were to be made yesterday.

On Tuesday hexavalent chromium was found in the drinking water of the plant. Traces of the toxic metal were discovered in four bathrooms and two bubblers in the rear of the plant.

Hexavalent chromium is used in recirculated water as an anti-corrosive and bacteria fighter. Officials said that because the plant was not in use, pressure in the recirculating water system built up, eventually backing up into the potable water system.

John Keating, sanitary engineer for the State Department of Environmental Quality Engineering, said Western Electric acted illegally in not having a backflow preventer where the pressure build-up occurred, but praised the company for reacting to the problem in an effective manner.

Quantities of 50 parts per million of hexavalent chromium were found in the drinking water, enough to cause severe vomiting, diarrhea and intestinal sickness, said Keating, who inspected the plant.

Coincidentally, a summer intestinal flu bug has been spreading in Greater Lawrence, but is not related to the contamination.

According to state toxicologist Halina Brown, the metal does not have long-term effects unless taken in large quantities over a prolonged period of time. The body has ways of cleaning out a one-time ingestion, she said, adding that it can be fatal if taken in large enough quantities.

Connors said the skeleton crew working last week was warned by signs and loudspeaker not to use the water.

Western officials said there were no reports of illness from the contamination. Keating said the company called area hospitals and employees who reported in sick to see if anyone was contaminated.

"It looks like they got on top of the situation pretty quickly," said Keating. "They're going to open the plant Monday, and they should be all set. There should be no problem."

In addition to correcting the backflow problem, Keating said plant officials thoroughly flushed the potable water system and ran multiple tests.

He said there would be no attempts to prosecute the company for violations because of the way company officials reacted to correct the problem.

"It was very serious, what happened," said Keating. "But the way they handled the situation I think is very good."

The sanitary engineer said he plans to continue inspections at the plant this summer.

A maintenance mechanic, in attempting to correct a fogging lens in an overcooled laser machine, installed a tempering valve. This inadvertently set the stage for a backpressure backflow incident that resulted in a toxic substance contaminating drinking water. The water affected was at the Western Electric Company in North Andover, Massachusetts, a large electronic manufacturing firm employing 9,000 employees. Quantities of 50 parts per million of hexavalent chromium were found in the drinking water which is sufficient to cause severe vomiting, diarrhea, and intestinal sickness. Maintenance crews working during the plant shutdown were able to eliminate the cross-connection and thoroughly flush the potable water system, thereby preventing a serious health hazard from occurring.

A large refrigeration chiller within the plant to primarily circulate chilled water for air conditioning purposes supplied a portion of the water to a laser machine in order to keep its lenses cooled during operation. The water used in the chiller system was treated with hexavalent chromium, a chemical additive used as an anti-corrosive agent and as an algicide to combat the buildup of bacteria in the closed loop, recirculated water system. This chilled water presented a toxic, non-potable substance unsuitable for human consumption but very acceptable for industrial process water. No hazard to health was present as long as the piping was well identified, kept separate from drinking water lines, and not cross-connected to the potable water supply.

A maintenance mechanic, seeing that the lenses of the laser machine were becoming fogged as a result of being excessively cooled by the chilled water supply, decided to correct the situation by installing a tempering valve in the chilled water pipeline leading to the laser machine. By so doing, he reasoned that he could warm up the chilled water supply to the laser and eliminate the fogging lenses. His theory was correct, since the tempering valve mixed the chilled water with hot water from a hot water heater, and the resulting warmer water solved the fogging lens situation. The problem with the installation of the tempering valve was that a direct cross-connection had been made inadvertently between the toxic chilled water and the potable water supply line.

During normal plant operation, the pressure balance at the tempering valve was such that the pressure coming from the plant chiller circulating pumps was approximately equal to the pressure in the line coming out of the hot water heater. With equal pressure inputs to the tempering valve, no over-pressure occurred at the cross-connection that resulted in any backpres-

sure bias. The system performed satisfactorily with no fogging of the laser lenses and no noticeable contamination of the potable water supply. However the stage had been set, for a crisis in the event of a pressure imbalance.

The chiller pumping system required repairs which were put off until the summer shutdown. To facilitate the use of the chiller during the required downtime, an alternate pump was temporarily installed. The temporary pump had the ability to build pressure up to 150psi. This promptly established an imbalance at the tempering valve, over-pressuring the 60psi potable supply. Backpressure backflow resulted and pushed the toxic chilled water into the water heater and then into the plant potable supply. Yellowish-green water started up out of the drinking fountains and into the washroom outlets.

Immediate action of maintenance personnel detected the cause of the problem. A backflow preventer was installed, and the lines thoroughly flushed. Over 500 tests were made of the potable water until no traces of the hexavalent chromium were found and the potable water declared safe. The 9,000 employees returned to work from vacation shutdown assured that the drinking water, contaminated while they were away, had been cleaned up.

This entire incident could have easily been prevented if a backflow preventer had been installed in the hot water supply line to the tempering valve at the same time the tempering valve was added. Backflow cases like this are being recognized on a daily basis; while only a few years ago, water contamination would be hushed up. Today, incidents are no longer being ignored or camouflaged; they are published in local newspapers and many gain national attention.

**ACTION . . .**

1. To stop backflow, utilize quality backflow preventers carrying one or more national organizational seats of approval, such as AWWA, USC, ASSE and CSA.
2. Employ trained mechanics, plumbers, pipefitters and mechanical contractors. Don't be afraid to ask to see their license to practice. If you employ in-house maintenance personnel, have them receive continuing education from local community colleges or vocational schools.
3. Review our local state and federal code. Codes are designed for the protection of life and property.
4. If, after all this, you are not certain that your piping system is properly protected, ask your safety committee to inspect it. They should solicit assistance from the plumbing inspector, health department or water purveyor.

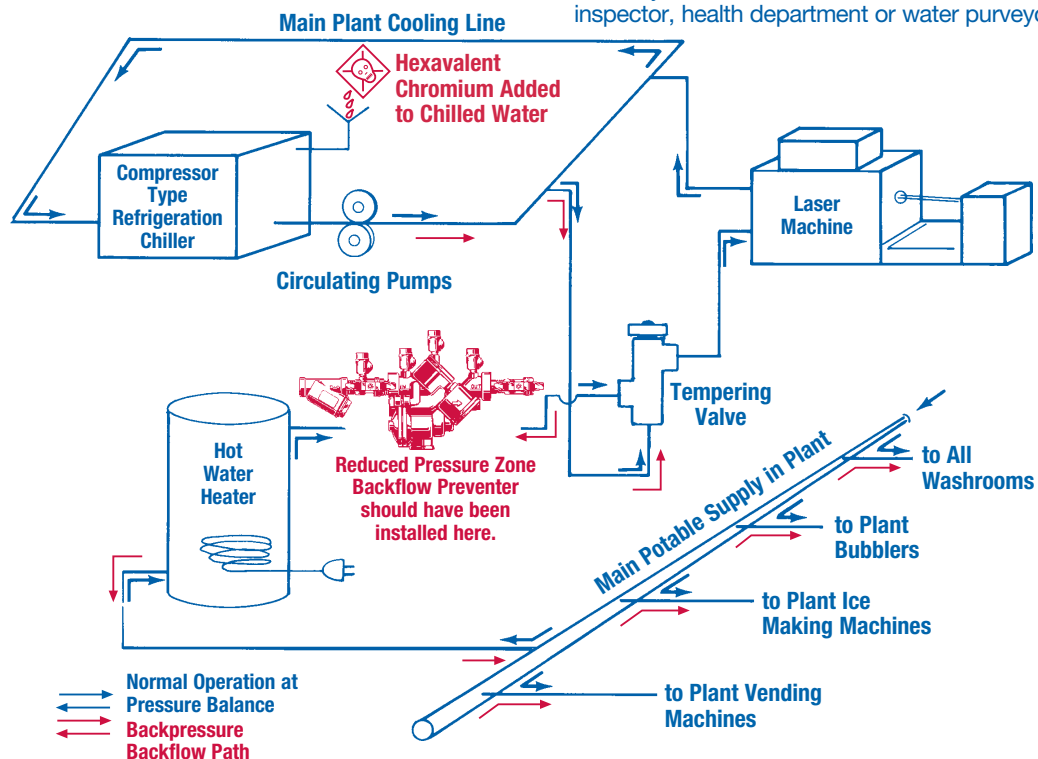



## **August 1982**

### **Backflow into the City Water Supply - propane gas**

Hundreds of people were evacuated from their homes and businesses on an August afternoon in a New England town. Fires were reported in two homes as a result of propane entering the city water supply. A work crew purging propane from a large propane tank that was in need of repair never checked the pressure in the propane tank which was greater than the pressure in the water line that fed it. As a result, propane vapor entered the water lines through backpressure forcing 500 people from their homes and contaminating the town water supply.

One five-room residence was gutted by a blaze resulting from propane gas “bubbling and hissing” from a bathroom toilet. In another home a washing machine explosion blew a woman against a wall. Residents throughout the area reported hissing, bubbling noises coming from washing machines, sinks and toilets. Faucets sputtered out small streams of water mixed with gas and residents in the area were asked to evacuate their homes by local firemen and other officials. Prompt action by police, gas company workers and water works personnel resulted in first sealing off the affected area, followed by individual house checks and the flushing of individual home plumbing systems, fire hydrant flushing and gas monitoring. Following lab testing of the water to determine that no gas was in the system, workers restored household water utility service. The temporary use of bottled water was discontinued. A thorough investigation by utility company representatives and state and local officials was launched to determine the exact cause of the problem. Revised propane purging procedures were promptly instituted.

**How could a near disaster of this nature occur and what could be done to prevent reoccurrence?**

A propane plant in the area consists of twenty-six sub surface 30,000 gallon capacity liquid propane storage tanks. Town water provides both fire and domestic water service to the gas company facility through an 8-inch combination service. It supplies two private hydrants and downstream of the last hydrant it reduces to a 3-inch domestic line which further reduces to a 1-inch domestic line servicing two buildings located on the site.

The procedure in progress, at the time of the accident, was a “purging” of one propane tank using water from one of the private hydrants located on the gas company property. There are two common methods or procedures for purging liquid propane tanks, i.e., using an inert gas such as carbon dioxide or the using water, which is the preferred method since it is more positive and will float out any sludge as well as gas vapors. In this case, water was used from one of the private hydrants on the property to the gas tank. The problem with this procedure was that the tank pressure was 85 to 90psi and the water pressure was only 65 to 70psi. The result was backpressure backflow of the propane gas into the water main. It was estimated that the gas flowed into the water mains for about twenty minutes and that about 2,000 cubic feet of gas was involved. This was approximately enough gas to fill one mile of an 8-inch water main.

The incident graphically illustrates the need for cross-connection control programs, to include:

1. Provisions for the installation of backflow preventers on private industrial fire protection systems - a frequently overlooked item in a cross-connection control survey.
2. Education of personnel associated with maintenance operations, stressing the problems involved when any potable water source is cross-connected to a potential higher pressure source or any source that could contaminate the public water supply.

### CONCLUSION:

1. Nothing should discourage local enforcement of cross-connection control measures. A comprehensive containment program for the protection of the public water supply, as well as internal isolation of known hazards per local plumbing codes, needs to be implemented.
2. Use of private fire hydrants for purposes other than fire protection is prohibited.
3. Consult your local Watts representative for cross-connection control products and literature.
4. An approved backflow preventer should be installed where the town supply enters the property. Subject to local and/or state approval, a Double Check Valve Assembly would be one means of protection with the provision that the device be tested at least twice a year.

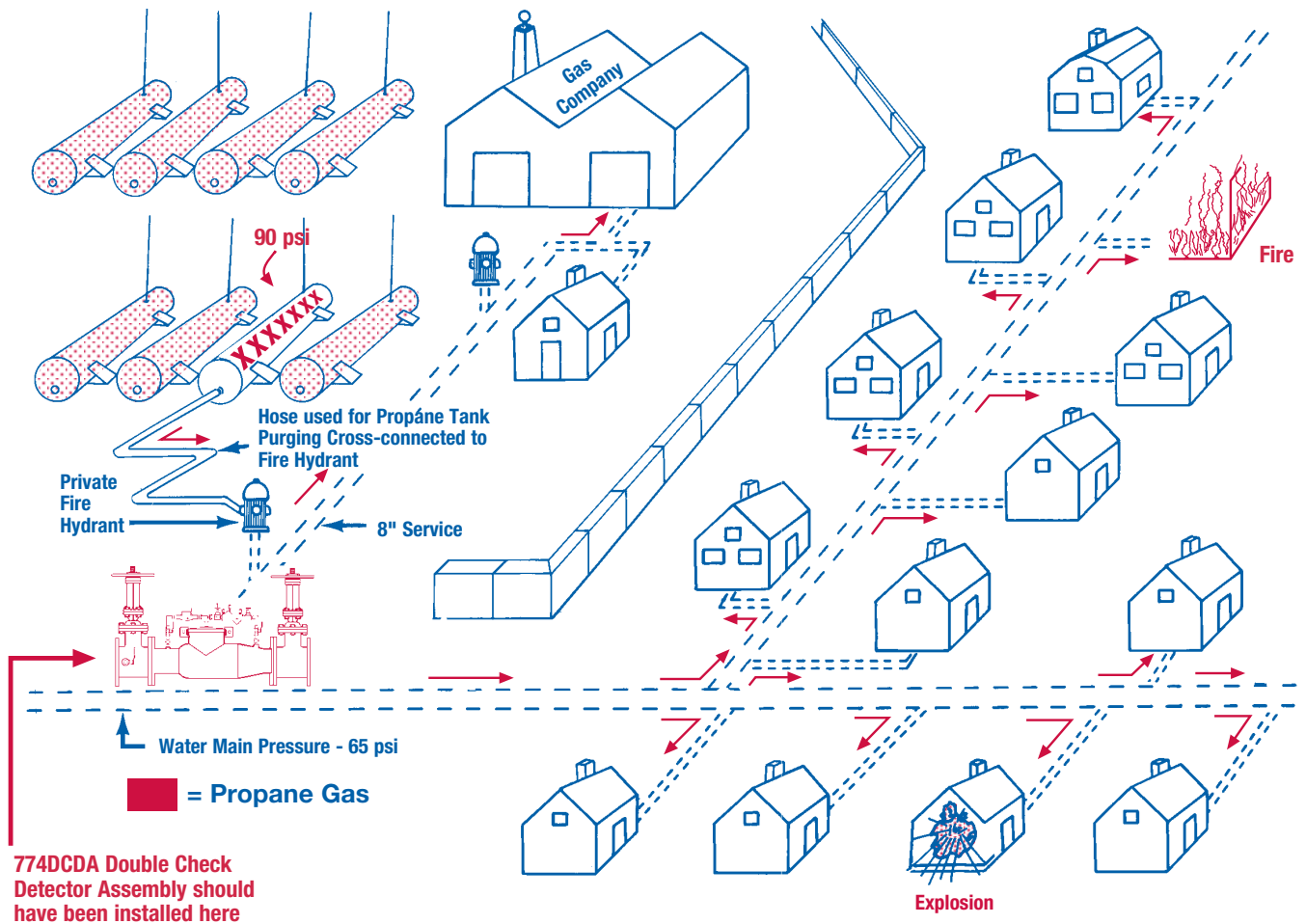

## September 1982

### Dialysis Machine Contamination - anti-freeze solution

In spite of a progressive backflow program, cross-connections and problems associated with cross-connections can occur in a community that are totally unexpected and unanticipated. Where the public health is concerned, constant vigilance is the key in preventing unforeseen cross-connections that can lead to very serious consequences. The following case highlights this problem:

In a large midwest city a coroner's jury recently ruled that renal dialysis machines that were accidentally contaminated by anti-freeze solutions in a large medical center were found to be a "significant condition" in the deaths of two patients. On the other hand, this same jury stated that "After listening to several doctors and pathologists, the jury unanimously agrees that the ethylene glycol contaminant did not contribute to the death of either man". In spite of this confusion, the fact is that the deceased persons were two of six patients who underwent dialysis at the medical in the fall of 1982. One died the following day and the other died 16 days later.

What is known is that ethylene glycol entered the dialysis equipment through a series of events triggered by a manually operated valve being left slightly open. The open valve permitted water to flow into a holding tank that was used to replenish a mix of glycol and water to the air conditioning system. The glycol is customarily utilized in air conditioning water to keep the water from freezing in cold weather. With the valve partially open, water continually flowed slowly into the glycol/water mixture holding tank until it filled to the point where the pressure in the closed tank equalled the pressure in the water supply system. At this point, the stage was set for disaster.

As long as the supply pressure in the line with the valve partially open did not decrease, no back-pressure flow would occur. If, however, the supply pressure dropped for any reason, the potable supply lines in the hospital would be contaminated with the glycol/water mix as the direct result of the cross-connection at the holding tank combined with backpressure backflow.

It is theorized that someone in the medical center flushed a toilet or turned on a faucet which, in turn, dropped the pressure in the water pipes and allowed the glycol/water mixture to drain out of the holding tank and into the medical center water pipes. In so doing, the contaminated water entered the dialysis filtration system that is used to purify the water for the dialysis machines. This filtration system takes out trace chemicals, such as those used at the city water treatment plant; however, the system couldn't handle the heavy load of chemicals to which it was suddenly subjected.

The effect on the dialysis patients was dramatic; patients became drowsy and confused. Some fell unconscious. All were moved promptly to intensive care where blood samples were taken. The blood samples revealed a buildup of acid and the medical director stated that, "Something has happened in dialysis." Dialysis was repeated on the patients a second and third time. In the meantime, detective work was initiated to determine the cause of the problem.

Test of the water supply to the filtration system determined the presence of "an undesirable chemical in the water purification system." The defective valve that had permitted water containing glycol to drain from the air conditioner holding tank into the dialysis filtration system and from there into the dialysis machines was discovered.

If the water supply to the glycol tank had been air-gapped or protected with a Reduced Pressure Principle Backflow Preventer, the incident would not have occurred. This highlights the need for hydraulic containment of other hazardous areas present in all hospitals and medical centers. Mortuary rooms, autopsy rooms, laundry rooms, boiler rooms, air conditioning units, pharmacy rooms should all be isolated and contained with the use of backflow preventers on their potable supply lines.

**Internal cross-connection control and containment would have prevented this dialysis accident.**

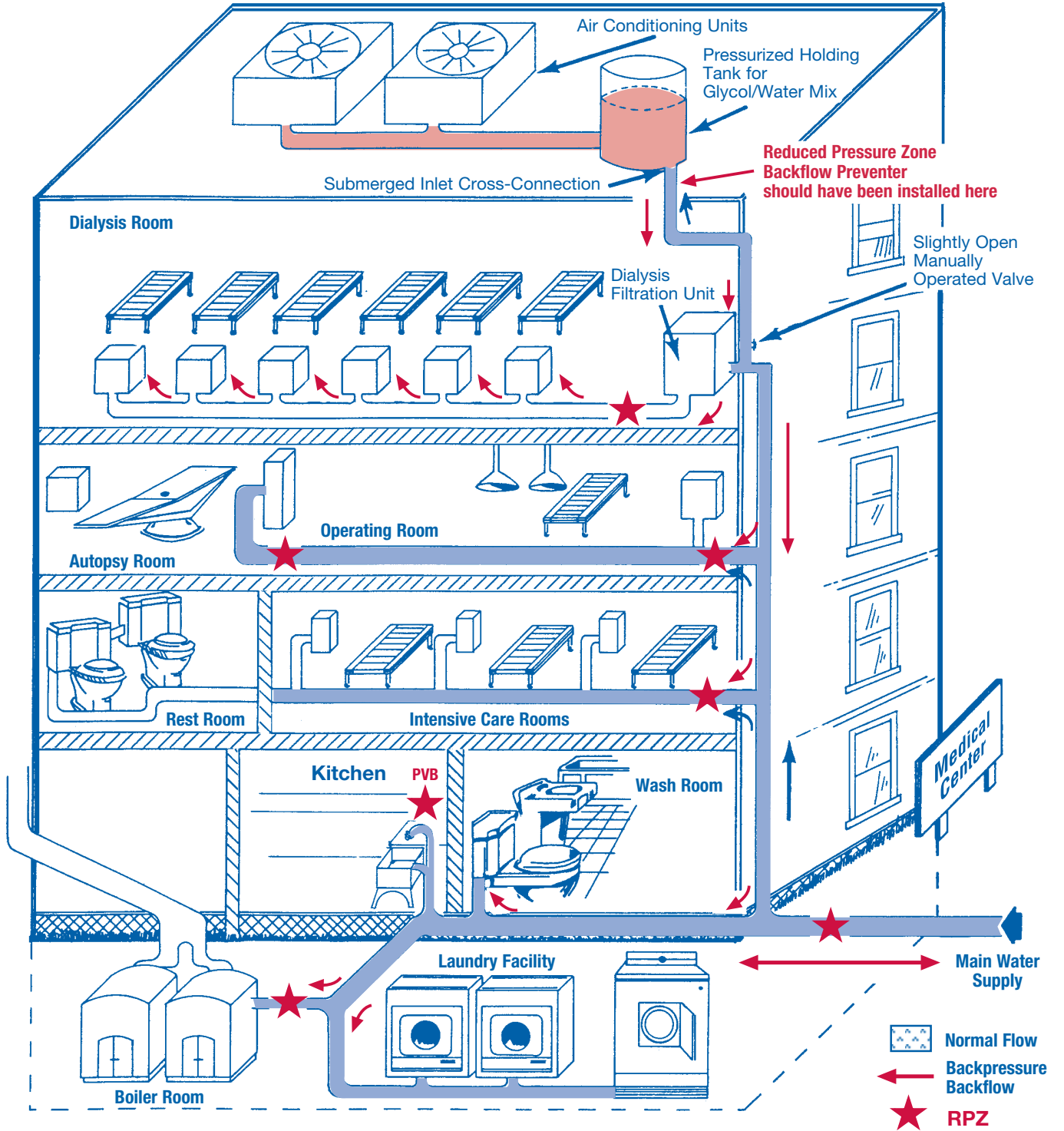



**June 1983**

## **Backflow Case - herbicide paraquat**

When a town has no backflow prevention program for its town water system, the system is out of control. An emergency intrusion of a foreign substance causes confusion and fear which is followed by tremendous unnecessary expense.

Members of the Woodsboro, Maryland Fire Company went door-to-door warning citizens of the danger of using town water which may have been contaminated with lethal pesticides. An ominous lighted sign, posted, at the Woodsboro Inn, greeted people entering town with the words "Welcome to Woodsboro, don't drink the water"

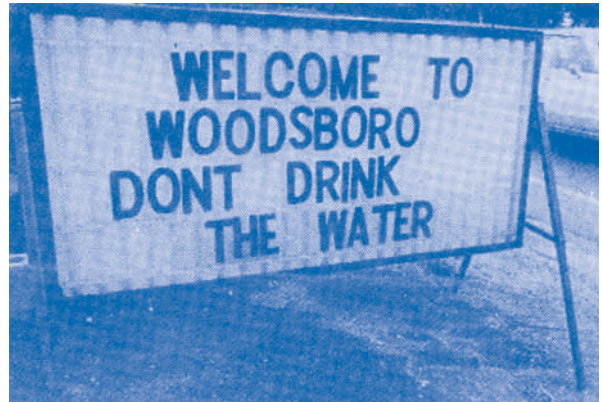

"Yellow gushy stuff" had poured from some of the faucets in town and the State of Maryland had placed a ban from drinking the Woodsboro water supply. Residents were warned not to use the water for cooking, bathing, drinking or any other purpose except for flushing toilets.

The incident drew widespread attention and made the local newspapers in addition to being the lead story on the ABC news affiliate in Washington, DC and virtually all the Washington/Baltimore newspapers that evening. The news media contended that lethal pesticides may have contaminated the water supply and among the contaminants was paraquat, a powerful agricultural herbicide.

Workers who had originally detected the problem notified the county health department, who in turn notified the state water supply division, who were promptly dispatched to take water samples for analysis. The Woodsboro water system was extensively flushed and a concurrent investigation undertaken to determine the source of the problem.

The investigation disclosed that the water pressure in the town water mains was temporarily reduced due to a water pump failure in the town water supply pumping system. Coincidentally a gate valve between a herbicide chemical holding tank and the town water supply piping had been left open. A lethal cross-connection had been created that permitted the herbicide to flow into the potable water supply system. Upon restoration of water pressure, the herbicide flowed into the many faucets and outlets on the town water distribution system.

This cross-connection created a needless and costly event that fortunately did not result in serious illness or loss of life. Door-to-door public notification, extensive flushing, water sample analysis, emergency arrangements to provide temporary potable water from tanker trucks, all contributed to an expensive and unnecessary town burden.

An effective town cross-connection control program could have simply and effectively averted the entire problem through enforcement of stringent containment control. The installation of a reduced pressure principle backflow preventer on the incoming potable supply feeding the herbicide holding tank would have effectively and inexpensively resolved the potential problem. A Watts 909 would have been a simple and cost-effective solution, versus the alternative of obtaining a separate source of water by drilling a private well.

## "Out-of-Control vs. Cross-Connection Control"

Out-of-control water supply cross-connections create needless hazards and emergencies. The cost to temporarily supply potable water is often not even considered as a factor. Properly installed Backflow Preventers are the only answer to eliminating such costly emergencies. An ounce of prevention is often equal to a pound of cure. To control out-of-control water supply cross-connections, install backflow prevention devices at all cross-connections in potable water distribution systems in accordance with the degree of hazard in each case.

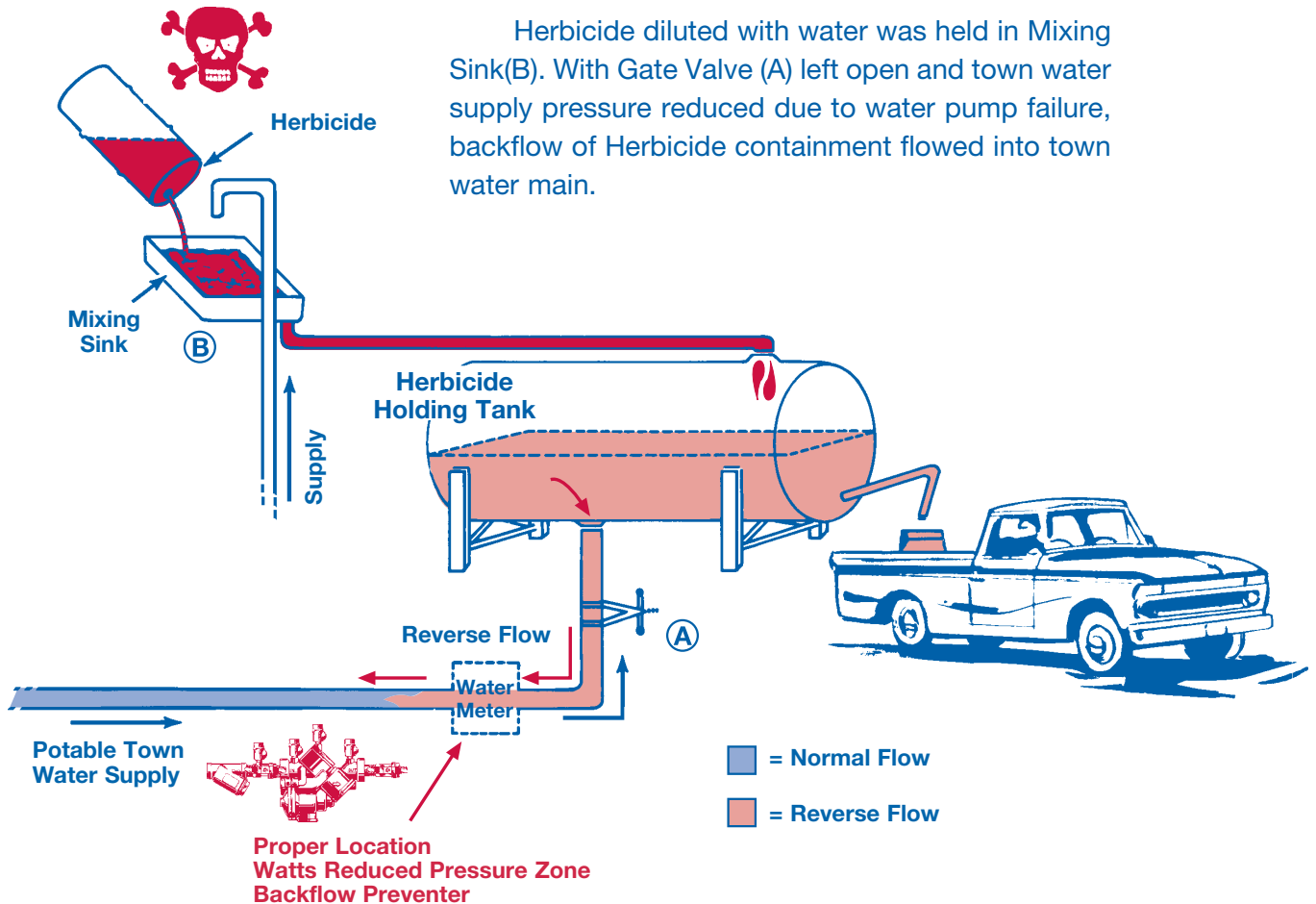

**July 1983**

## **Shipyard Backflow Contamination - raw river-water**

Water fountains at an east coast shipyard were posted “NO DRINKING” as workers flushed the water lines to eliminate raw river water that had entered the shipyard following contamination from incorrectly connected water lines between ships at the pier and the yard. A third shift workman paused at a fountain for a drink shortly after reporting to work and remarked, “You couldn’t believe what it tasted like.” Some third shift employees drank the water before the pollution was discovered and later complained of stomach cramps and diarrhea.

Upon notification, the shipyard trucked in potable water and had trucks stationed throughout the shipyard so that employees could obtain drinking water. Warning signs were posted at drinking fountains and flushing of the mains was started together with beefing up of the chlorine content to disinfect the system. Fortunately, the contamination was confined just to the areas of the shipyard complex and not the adjacent city water supply system. This was confirmed by water tests conducted by the shipyard laboratory and state officials.

The cause of the problem was a direct cross-connection between the on-board salt water fire protection water system and the fresh water connected to one of the ships at the dock. While the shipyard had been aware of the need for backflow protection devices at the dockside tie up area, the devices had not been delivered and installed prior to the time of the incident. As a result, the on-board salt water fire protection system, being at a greater pressure than the potable supply, forced the salt water through backpressure into the shipyard potable supply.

Fortunately, a small demand for potable water at the time of the incident prevented widespread pollution in the shipyard and the surrounding areas.

Investigation by shipyard personnel into the cause of the incident disclosed that it was standard operating procedure to require the hookup of a potable supply line to a dockside backflow preventer with subsequent connection to shipboard service. The lack of a backflow prevention device at the dock resulted in a direct connection between the potable supply at the dock and the ship. Reduced pressure principle backflow prevention devices have been subsequently installed at dockside and the shipyard potable supply from the town has been protected with the installation of large backflow prevention devices.

Had the backflow devices been in place and utilized according to established procedures, the entire incident would not have occurred. Education and the firm commitment to established procedures is all important in the protection of cross-connections for public health.

When the pressure P1 is greater than the water main normal pressure P2, backflow occurs.

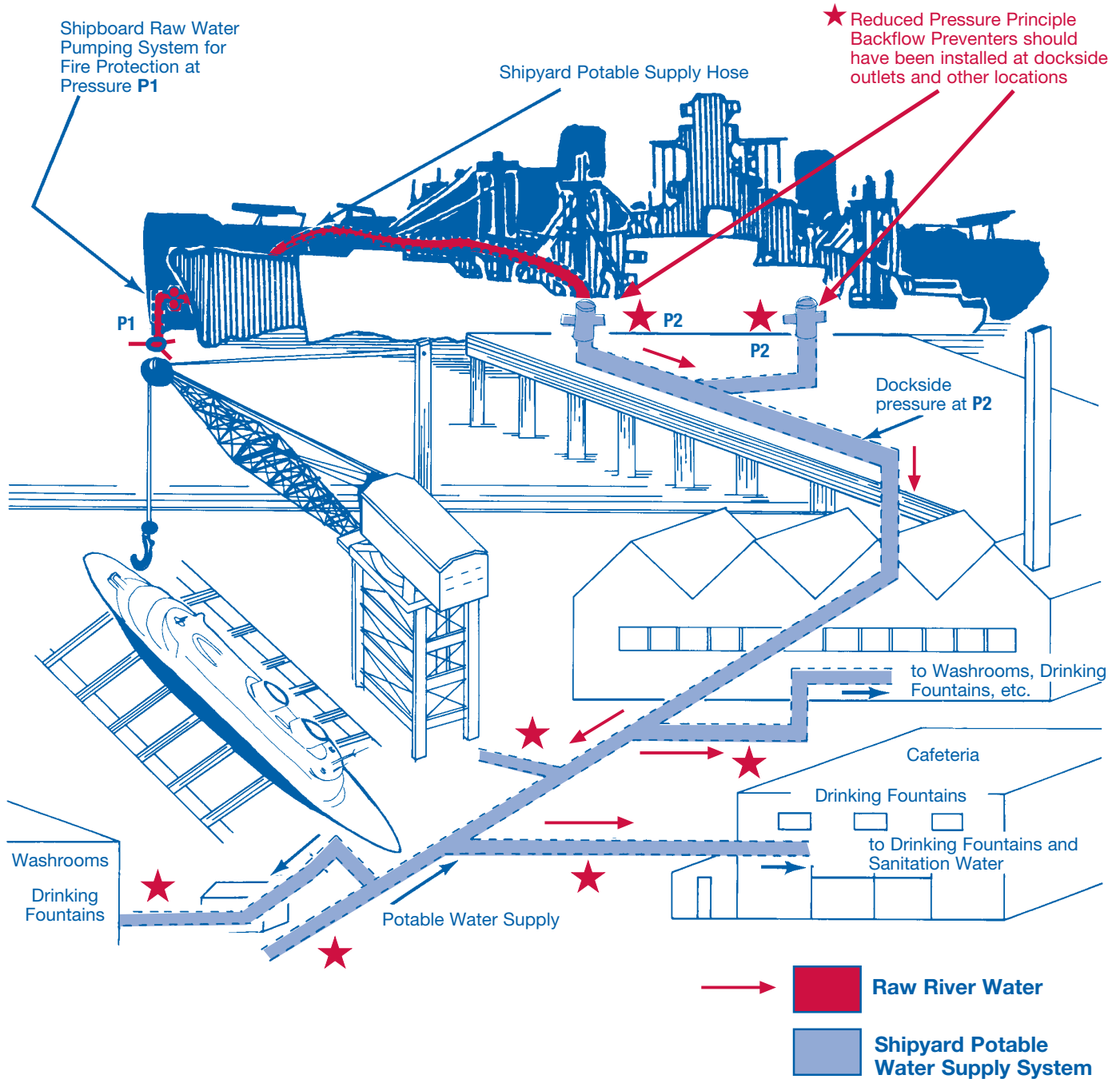



**June 1984**

**Backflow Case - Farmington, New Mexico, High School -  
chromium sodium dichromate**

FARMINGTON  
**DAILY TIMES**  
*San Juan County's Newspaper*

Friday Evening June 1, 1984

Published Daily in  
Farmington New Mexico

VOLUME 96  
Number 304

Two Sections

Farmington High School was closed for several days, when it was noticed by a home economics teacher, that the water was yellow. City chemists determined that samples taken contained levels of chromium as high as 700 parts per million, "astronomically higher than the accepted levels of .05 part per million." Gary Lee, head chemist with the city of Farmington, said it was miraculous that no one was seriously injured or killed by the high levels of chromium. No one knew how much of the chromium had run through the water system at the school before the situation was noticed and samples taken. The chemical was identified as sodium dichromate, a toxic form of chromium. It was agreed, that a person could get very sick or possibly could die, if the water had been consumed.

No students or faculty were known to have consumed any of the water; however, area physicians and hospitals were advised, that if anyone had taken in those high levels of chromium, the symptoms would be nausea, diarrhea, and burning of the mouth and throat. Fortunately, the home economics teacher, who first saw the discolored water before school started, immediately covered all water fountains with towels so that no one would drink the water.

Investigation disclosed, that chromium used in the heating systems boilers to inhibit corrosion of the metal parts, entered the potable water supply system of the school, as a result of backflow through leaky check valves on the boiler feed lines.



The check valves were replaced with Watts series 909, reduced pressure principle backflow preventers.

The high hazards associated with commercial boilers cannot be overemphasized: Toxic rust inhibitors and defoamants that are routinely added to these boilers are an ever threatening toxic potential to the potable water supply. The superior pressure in the boilers, together with the toxic nature of boiler water, are an ever present menace to industrial, commercial, hospital, schools, colleges and university water systems. The use of reduced pressure principle backflow preventers on all of these boiler feed lines, and make-up lines, is an essential ingredient of all effective cross-connection control programs along with federal and state regulations. Effective cross-connection control also includes Certified Backflow Testers and semi-annual testing program.

For superior protection, use the Watts 909 Series, reduced pressure principle backflow preventers. They are available for cold and hot water installations configurations and incorporate the unique "air-in-water-out" principle, that provides advanced state-of-the-art protection.

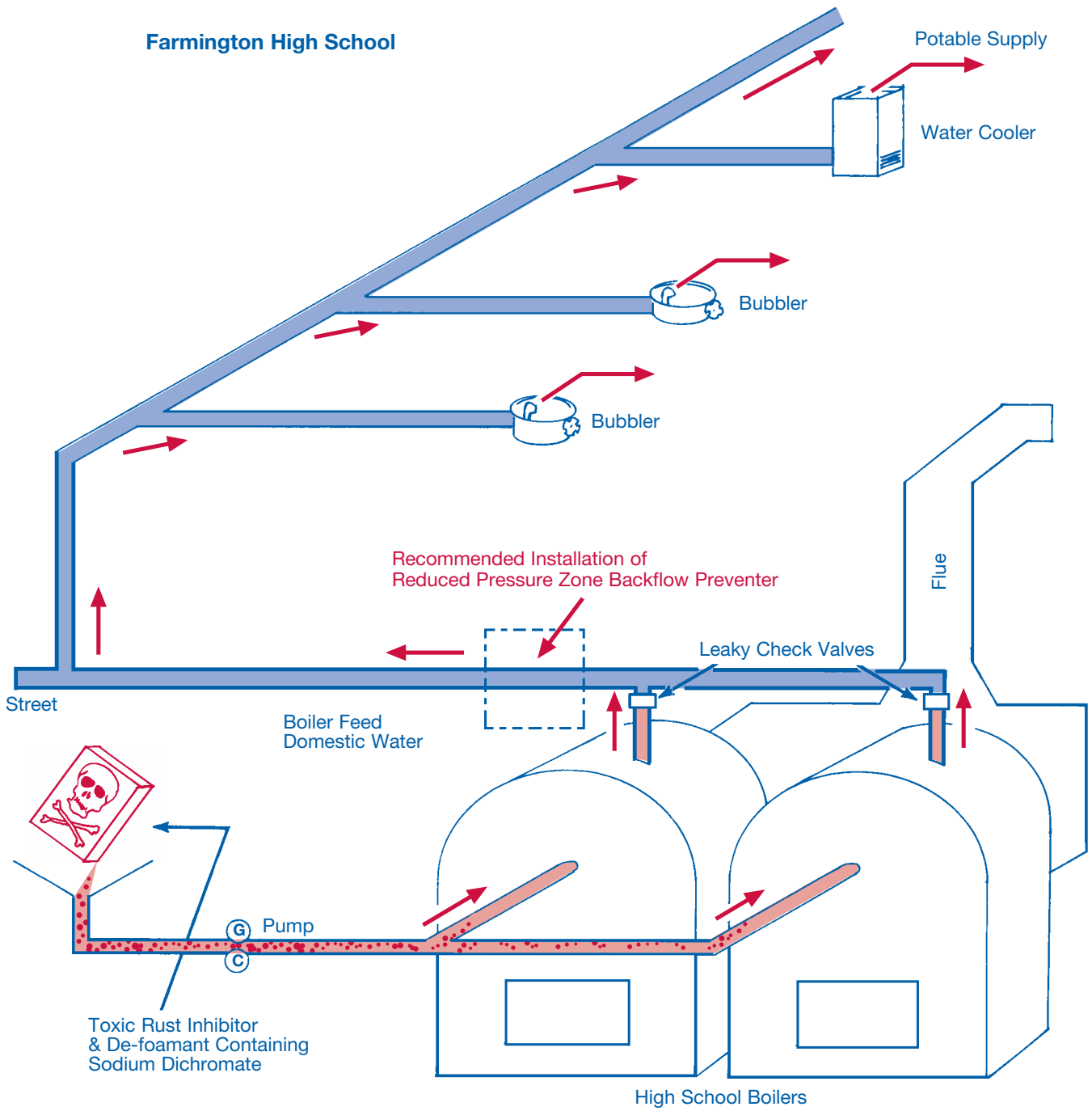
# Farmington High School



-  Backpressure Route of Toxic "Chromates"
-  Potable Water Supply System

## November 1984

### Backflow of creosote into potable water in Macon, Georgia

Creosote entered the water distribution system of the Macon-Bibb County Water Authority in Macon, Georgia, as a result of a cross-connection between a  $\frac{3}{4}$ " hose being used as a priming line between a fire service connection and the suction side of a creosote pump. The hose continually supplied water to the pump to ensure the pump was primed at all times. However, while repairs were being made to a private fire hydrant, the creosote back-siphoned into the water mains and contaminated a section of the water distribution system.

The sequence of events occurred as follows:

A company utilized creosote under pressure to produce railroad ties and telephone poles. On November 17, 1984 at 9 A.M., the company called the distribution department of the Macon-Bibb County Water Authority in Macon, Georgia and requested that their water service be turned off so that repairs could be made to one of their private fire hydrants. The company was supplied non-metered water from two six-inch mains located at opposite sides of their property. The company had the capability to shut off their water supply to only one of the two service lines. The Macon water company was needed to shut down the other six-inch service line.

At 3 P.M. the same day, the company called the water department and reported that the repairs had been made, and requested that their water service be restored. This was done by 4 P.M.

At 6 P.M., customer complaints began coming in to the water department relative to bad tasting water. Prompt response resulted in the flushing of adjacent fire hydrants and the collection of samples for analysis. Samples did detect creosote and both valves supplying the wood preservative company were immediately closed.

Water and Sewage Authority crews began opening fire hydrants located within a tight radius of the wood preservative company in an effort to cause a reversal of water flow in the distribution system. This would allow the contamination to be brought back to the source, as opposed to further dispersion into the far reaches of the water distribution system. All local radio stations were notified, as well as Civil Defense, EPA, the Fire Department, and the Police Department. Hospitals and clinics were notified and briefed on the possible chemical constituents of the contaminants. Persons on life-support systems and those who suspected they had consumed some of the contaminated water were given instructions on what to do and whom to call.

Flushing continued and a complete reversal of the water flow was achieved by 7:30 P.M. Until midnight, crews traveled from fire hydrant-to-fire hydrant and house-to-house, taking water samples. At 3:00 P.M. on November 18, 1984, laboratory analysis indicated that the system was free of contamination. Residents were notified that they should flush their plumbing for thirty minutes, and that their water bills would be adjusted accordingly.

Following flushing of the wood preservative company's system for twenty-four hours, it was discovered that creosote had reached, and still remained in, the far areas of their fire system. Backflow preventers were installed and all lines on the property completely flushed prior to restoring service. Detailed investigation into the cause of the incident disclosed that the wood preservative company, as part of their operation, pumped creosote from collective pits to other parts of their operation. The pump automatically shuts off when the creosote in the pit is lowered to a predetermined level. After the creosote level returns to a higher level, the pump restarts. This pump, however, quite often would lose its prime prior to the pit refilling. To prevent the loss of the prime, the wood preservative company connected a hose from a  $\frac{3}{4}$ " hose bibb located on the fire service line to the suction side of the pump. The hose bibb remained open continuously in an effort to keep the pump primed at all times.

It was necessary to remove the damaged hydrant in order to make repairs, and since it was at a significantly lower level than the creosote pit, the creosote back-siphoned through the  $\frac{3}{4}$ " pump priming hose connecting the creosote pit to the fire service line.

After the repairs were made to the hydrant, and the water service restored, the creosote now in the fire lines was flushed out into the main water distribution system.

This case history presents several lessons and considerations on the subject of backflow prevention as it pertains to degree of hazard and device selection:

1. Had Watts 909 reduced pressure zone backflow preventers been installed on both six-inch service entrance lines prior to the incident, the creosote contamination would have been contained within the confines of the wood preservative plant (the containment approach to backflow prevention), and not spread to the adjacent homes.
2. The actual cross-connection created by the  $\frac{3}{4}$ " hose, hooked up between the fire line service and the suction side of the creosote pump, represented an extremely high hazard. Consideration should have been given to installing a  $\frac{3}{4}$ " permanent water pipe as a priming line and utilizing a Watts  $\frac{3}{4}$ " 909 reduced pressure zone backflow preventer in this line.
3. Since the wood preservative company utilized a metered domestic water line, branched off the fire line service, a Watts 909 reduced pressure principle backflow preventer should have been installed at the meter to prevent potential contamination of the internal potable water supply from creosote.

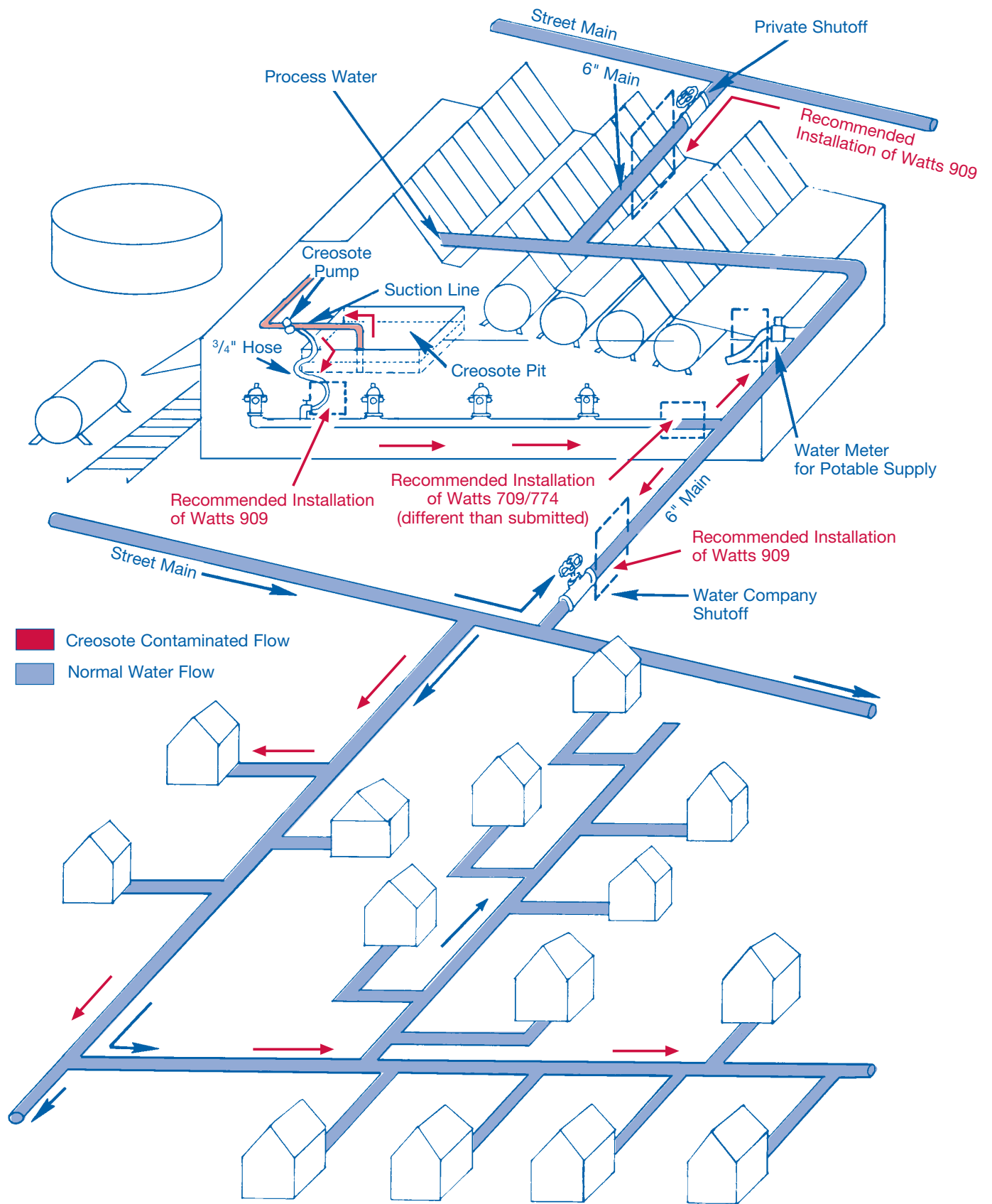



**April 1986**

## **Backflow of Pesticide into the Potable Water**

**2B THE FAYETTEVILLE TIMES, Thursday, April 24, 1986**

# **Hope Mills Says Pesticide Found In Water**

By JEFFRY COUCH  
Of The Times Staff

HOPE MILLS - A pesticide contaminated what appeared to be a "small" part of the Hope Mills water system last week, prompting the town to warn residents of about 23 households not to drink their water, officials said Wednesday.

The warnings, which affect two to three blocks in the North Main Street area, will remain in effect until officials determine that the contamination has been flushed out of the system and is not in the pipes of individual residences, according to state and local officials.

Residences along Phillips Street and Fountain Lane were sent warnings, according to Hope Mills Interim Town Manager John Beasley.

Residents in the affected area are being supplied water from a tank parked in the parking lot at the Lakeview Office Building, Beasley said.

Some residents had reported smelling an odor in their water but there have been no reports of illness from ingesting the water, contaminated with a pesticide containing the chemical chlordane and heptachlor.

A state toxicologist said the contamination is not "dangerous to anybody right now."

"We think it's probably flushed out," Beasley said.

The state Department of Agriculture is investigating how the contamination occurred, according to Wally Venrick, regional engineer for the state Division of Health Services Water Supply Branch.

Authorities believe the problem occurred last week when a water line broke along North Main Street.

Workers from the Economy Pest Control Service at the Lakeview Office Building on North Main Street were filling one of the pesticide truck tanks with water when the break occurred and pressure in the waterline was reduced, causing material from inside the tank to be sucked into the building's waterline, authorities said.

The pesticide is used to kill "termites and bugs," according to Frank Morris, assistant regional engineer for the Water Supply Branch.

Contacted at his home Wednesday night, Ted Taylor, the state toxicologist said there "is no imminent health hazard."

The highest contamination level was detected April 17 in the Lakeview Office Building, Morris said. He said tests showed there were 5.5 parts per billion of heptachlor in the water.

On Friday afternoon, .07 parts per billion of chlordane and .04 parts per billion of heptachlor were detected in water sampled from one fire hydrant near the building, he said. At two other hydrants, contamination was not detected, according to Morris.

On Wednesday, the Water Supply Branch took additional samples from three homes and a drive-in restaurant and a bait and tackle shop on North Main Street.

Officials said the restaurant owner closed his business on his

own Wednesday, while there has also been a report that about 1,000 minnows died at the bait and tackle shop after the water was changed in the tank. But officials said they do not know if the contamination has anything to do with the minnow's deaths.

A private company took samplings from the Phillips Street and Fountain Lane residences and from some businesses along North Main Street Tuesday to determine if the water is contaminated, according to Beasley.

Fire hydrants are being flushed and residents have been urged to drain their lines and hot water heaters, Beasley said.

After the incident, the Lakeview building's water supply was cut off from the town system to try to prevent contamination, officials said.

The first written notices from town officials warned people not to use the water for "human consumption or bathing" if they detected an odor like gasoline or petroleum.

The Tuesday notices just warned them not to use water for drinking or cooking.

**June 1986**

## **Residential Containment - Bangor, Maine**

From a [Penobscot News](#) article

Most towns, cities and counties in the U.S. have heard about the residential back-flow preventer. Every day there is a new water company putting forth an effort to protect the primary water system from backflow contamination.

The protection programs consist of:

- (A) Plumbing code requirements: solution of the potential hazard or internal protection (considered the first line of defense)

Plumbing codes are very specific here. They generally require backflow protection as follows:

1. Air gaps to be built into sink, tub and basin faucets.
2. Anti-siphon type ballcocks are required on water closets (toilets).
3. Backflow preventers or vacuum breakers on lawn sprinklers.
4. Vacuum breakers on hose bibbs and sill cocks.
5. Backflow preventers on supply lines to boilers or other equipment containing non-potable fluids and cross-connected to the potable water system.

Because some local authorities modify existing national codes, certain areas require backflow protection on the following as well:

1. Residential swimming pools, hot tubs and spas.
2. Residential solar heating systems.
3. Private wells and other auxiliary water supplies.

- (B) Water utility requirements: containment or a backflow preventer at every meter (considered the second line of defense)

Since most water purveyors are concerned that the plumbing code enforcement may not be adequate enough to guarantee primary system backflow protection, they are requiring a second line of defense. An article from the "Penobscot" Sat. - Sun. June 21-22, 1986 indicates what was done by the Bangor Water District to establish a "second line of defense". They utilized a dual check at every residential water meter.

This is based upon the same common sense that we find in the excerpt from the AWWA policy statement as shown below.

"If, in the opinion of the utility, effective measures consistent with the degree of hazard have not been taken by the regulatory agency, the water purveyor should take such measures as he may deem necessary to ensure that the primary distribution system is protected from contamination. Such action would include the installation of a backflow prevention device, consistent with the degree of hazard, at the service connection (dual check at every meter) or discontinuance of the service".

## March 1985 and April 1987

# Ethylene Glycol in Air Conditioning Cooling System and Heating System Contaminates Water Systems

The Center for Disease Control, reported in their Weekly Morbidity and Mortality Report, September 18, 1987, (Vol. 36/No. 36), that two instances of contamination of the potable water supply systems had been encountered due to ethylene glycol backflowing into the potable water supply. The first incident occurred in New York in 1985, and the second, in North Dakota, in 1987.

## Case 1

In March 1985, a hospitalized women in New York died one day after being exposed to ethylene glycol while undergoing hemodialysis treatment. A review of the accident disclosed that the hospital's water system, which was the source of water used to prepare the dialysis fluid, had become inadvertently contaminated when the air conditioning system was flushed with a commercial solution that consisted of 95% ethylene glycol together with a market dye.

A direct connection between the potable water supply and the chilled water circuit of the air conditioning system was open for flushing of the chilled water circuit when the chilled water pump was activated. A check valve in the potable water supply system failed to prevent backflow from the pressurized circuit into the potable water system. While the contamination was detected in other areas of the hospital, it went unrecognized in the dialysis unit!

The patient suffered a coma, metabolic acidosis, and irreversible shock 12 hours later. One hospital worker had taken a sip of the contaminated water but had not swallowed it because of its taste and obvious discoloration.

The cross-connection of the potable water supply to the chilled water circuit of the air conditioning system, was inadequately protected with a simple plumbing check valve! The high degree of hazard inherent in this type of potable water supply make-up system requires the installation of reduced pressure principle backflow preventers to insure positive protection to the potable water supply system. Simple plumbing check valves are totally inadequate for use on high hazard installations as this tragic case documents.

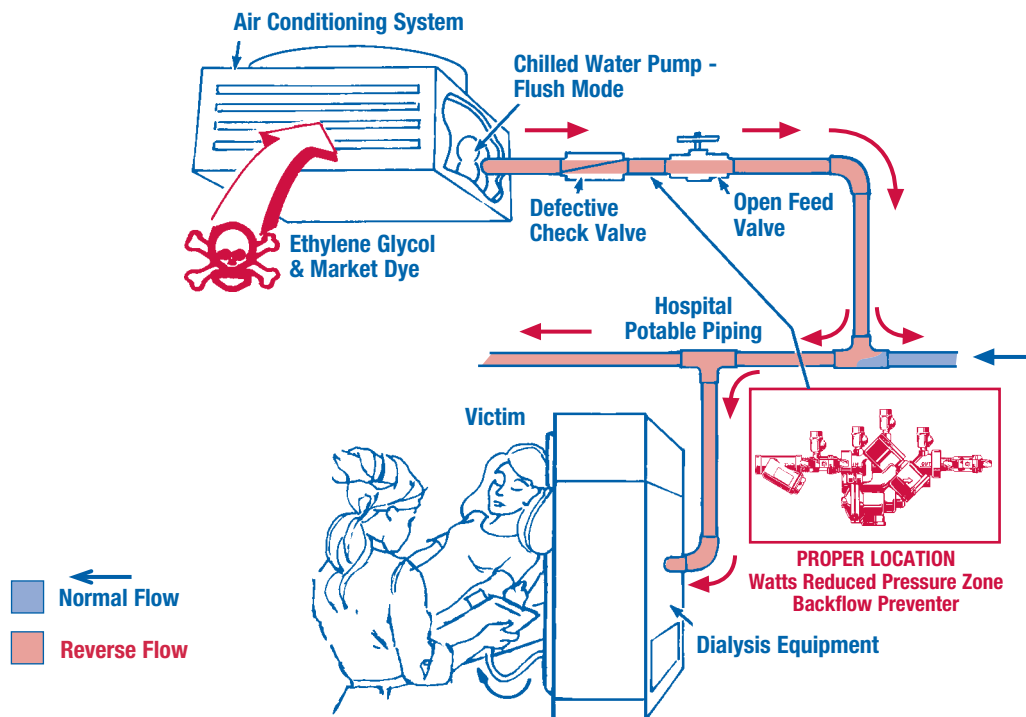

## Case 2

In April 1987, two children, ages 4 and 7, were admitted to a rural North Dakota hospital because of acute drowsiness, vomiting, and loss of muscle coordination. Following transfer to a Fargo hospital, toxicological studies revealed the presence of ethylene glycol.

On the day of the illness, both children had been at a picnic attended by approximately 400 persons at a fire hall in rural North Dakota. Extensive investigation of all persons attending the picnic revealed that one food item, a non-carbonated soft drink, was strongly associated with the illness of 28 people.

The water used to prepare the powdered beverage had been drawn from a spigot nearest the fire hall's heating system. The heating system used a mixture of water and anti-freeze and was cross-connected to the potable water supply to make up feed water. The feed water was regulated by a single hand shut-off valve. A water sample taken at the spigot the evening of the picnic had an ethylene glycol concentration of 9%!

The cross-connection between the potable water supply feed to the heating system that utilized ethylene glycol was totally unprotected. Again, the high degree of hazard requires the use of reduced pressure principle backflow preventers on the potable water feed to the heating system.

**Center for Disease Control Editorial Note:** "Ethylene-glycol-based" heating systems, which have been increasingly popular in North Dakota in the last few years, are usually designed to circulate a heated mixture of ethylene glycol and water through the pipes imbedded in concrete floors. These systems are most often found in farmer's workshops and auto repair shops."

These two documented cases strongly support the need for the installation of approved backflow prevention devices on potable water feeds to air conditioning cooling systems and commercial heating systems. Only through aggressive educational programs, and constant awareness on behalf of plumbers, plumbing inspectors, town officials, water department personnel, and the public, can situations like these be eliminated and the safety of the public health be assured.

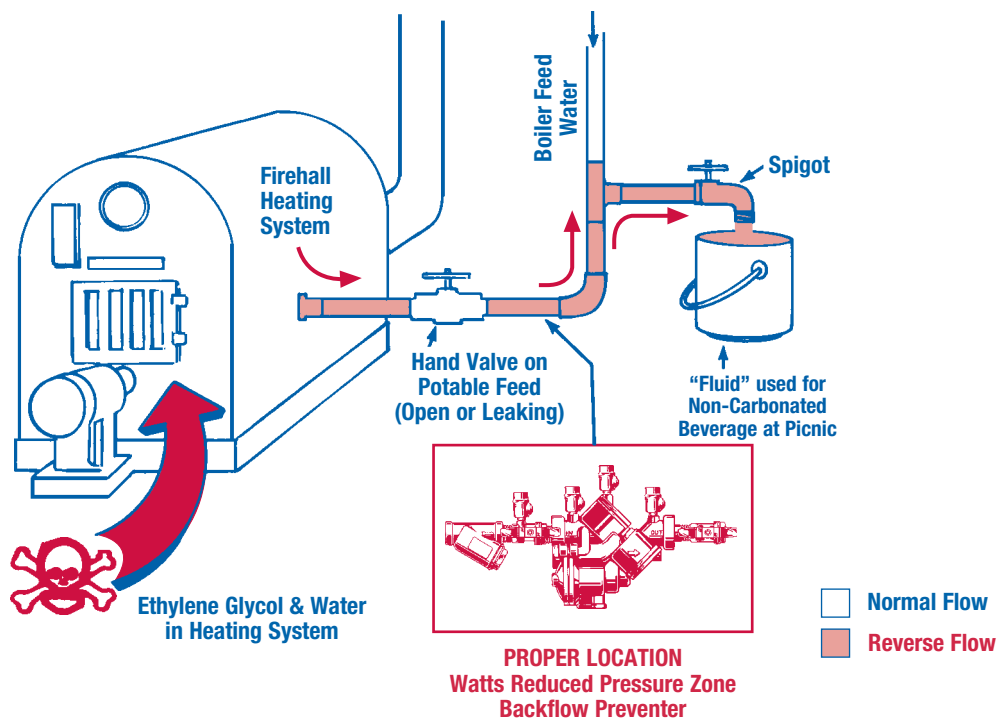



## **October 1986**

### **Burned In the Shower - sodium hydroxide**

A resident of Lacey's Chapel, Alabama, jumped in the shower at 5 a.m. one morning in October, 1986, and when he got out of the shower his body was covered with tiny red blisters. "The more I rubbed it, the worse it got", the 60-year-old resident said. "It looked like someone took a blow torch and singed me."

He and several other Lacey's Chapel residents received medical treatment at the emergency room of the local hospital after the water system was contaminated with sodium hydroxide, a strong caustic solution.

Other residents claimed that "It (the water) bubbled up and looked like Alka-Seltzer. I stuck my hand under the faucet and some blisters came up." One neighbor's head was covered with blisters after she washed her hair and others complained of burned throats or mouths after drinking the water.

The incident began after an 8-inch water main broke that fed the town of Lacey's Chapel from the Bessemer Water Service. While repairing the water main, one workman suffered leg burns from a chemical in the water and required medical treatment. Measurements of the ph of the water were as high as 13 in some sections of the pipe.

Investigation of the problem led to a possible source of the contamination from a nearby chemical company which distributes chemicals such as sodium hydroxide. The sodium hydroxide is brought to the plant in liquid form in bulk tanker trucks and is transferred to a holding tank and then pumped into 55 gallon drums. When the water main broke, a truck driver was adding water to a tanker truck that had carried sodium hydroxide. Unfortunately, the driver was adding the water from the bottom of the tank truck instead of from the top. As a result, the sodium hydroxide back-siphoned into the water supply system.

The seriousness of this backsiphonage incident, and its impact on the entire community of Lacey's Chapel, is obvious. Had the truck driver added the water from the top of the tank truck, through a normal air gap, the sodium hydroxide contents could not have back-siphoned through the hose and into the potable water system. Even if the truck driver utilized the top fill of the tank truck, it is possible that he could have pushed the hose deep into the tank which would have compromised an air gap, and the sodium hydroxide still could have back-siphoned up through the hose, and entered the potable water supply system.

The incident emphasizes the need for education of all concerned in the handling and transfer of bulk hazardous liquids. Awareness of possible cross-connections with the potable water supply system when diluting or washing out a hazardous chemical contained in any tank or reservoir with a hose connected to a potable supply is the key to fluid transfer safety.

Had an inexpensive Watts No. 8 hose bibb vacuum breaker been installed on the hose bibb to which the hose was attached that led to the tank truck, the backsiphonage incident would never have occurred.

### **Backflow prevention programs are important!**

The water company authority in Lacey's Chapel is responsible for supplying drinking water and, along with it, the implied warrantee that the water is safe to drink, even to the last tap. Without a backflow prevention program which involves the water user, this is needlessly assuming the total legal liability for safe drinking water. Backflow prevention programs that require the end user to maintain Plumbing Code compliance for his safety and containment control for additional protection, benefits the community water supply as well as the water user. For the water supplier to operate without a formal on-going backflow prevention program places him and the community at risk of financial disaster from law suits, and the consumer at jeopardy from backflow danger in the form of injury or death. What is the point of not having a Backflow Prevention Program? It's a no win situation for the water supplier, water user and the local community where backflow danger surely lurks.

Today the water systems are more complicated than ever before in the history of water. The opportunity for an accident involving the pollution or contamination of the water is alarming and more likely than ever. Recently it was discovered that insurance companies are not protecting subscribers in cases of pollution or contamination since they feel that pollution and contamination have already contributed too much to the insurance crisis in America today.

Water utilities that provide water and practice back flow prevention, as well as owners of facilities under the jurisdiction of cross-connection control programs as specified in the plumbing codes, all control water piping systems. They allow people to unrestrictedly utilize the water and they have major responsibilities such as:

1. Comply with latest safety precautions. (Random sample and water testing)
2. Survey the system to identify actual or potential problem areas.
3. Install, test, and maintain approved backflow prevention devices.
4. Keep records.
5. Develop a contingency plan to prevent any unnecessary injury or possible damage resulting in deaths, when an incident is discovered, ie., STOP PEOPLE FROM DRINKING THE WATER. All states are required to have such a plan. It would be beneficial for water purveyors to review same.

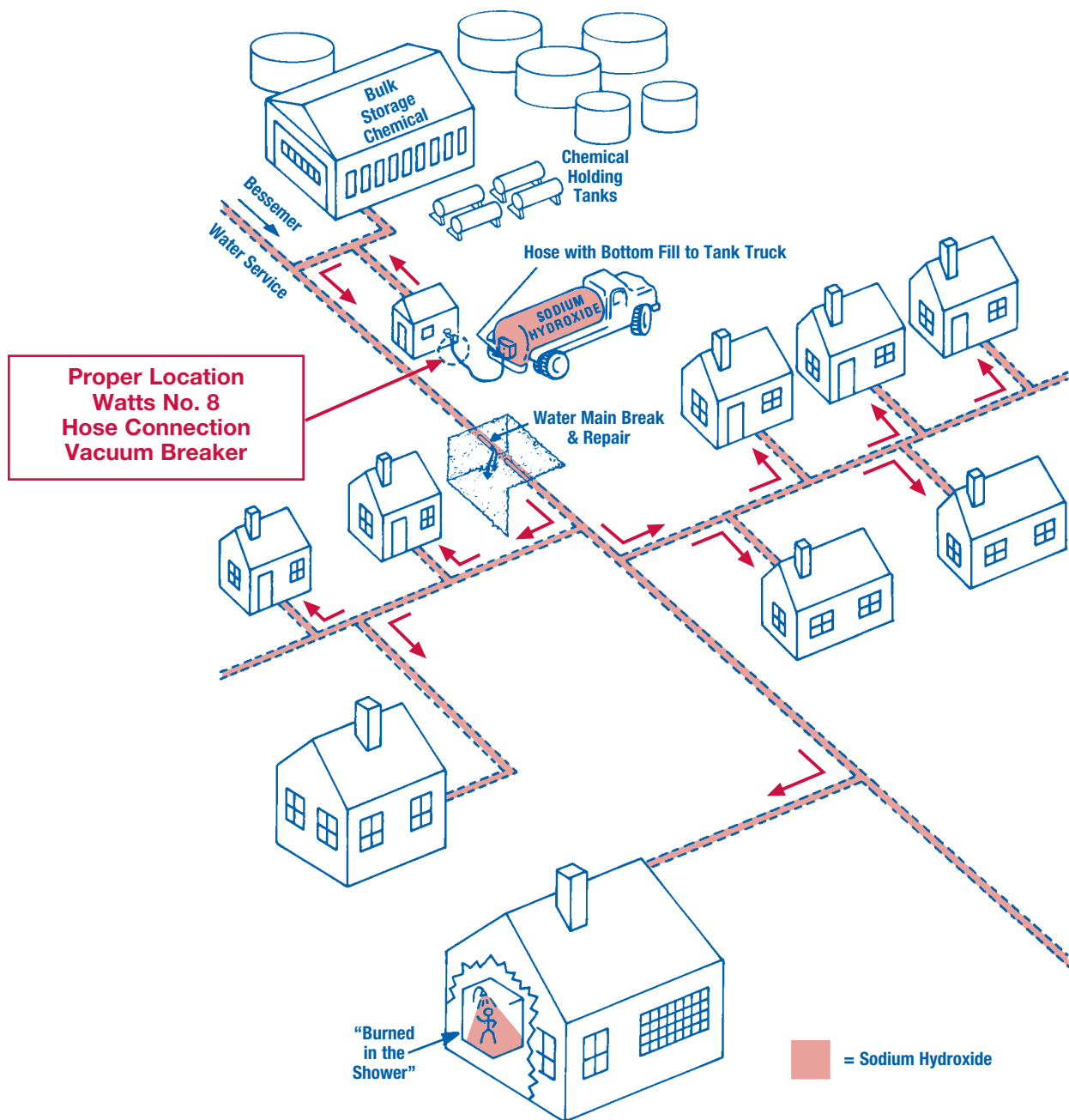

**June 1987**

**Pesticides Contaminate 63 Homes - 21 Million Dollar Lawsuit Follows**

Sixty-three homes were without water in a northern New Jersey municipality because a pesticide used for termite control was found in the water supply. The pesticide, primarily consisting of Dursban, was found in the potable water supply to these homes and was discovered after workers repaired a water main break. Several hours after the water main break was repaired, a customer called the water department to complain that the water was milky and smelled bad. "I put the water on and it came out white like milk and had an odor," the customer said.

Officials immediately cut off the water supply to the 63 affected customers and notified them orally and in writing not to drink the water or use it to cook, bathe, or wash clothes. Officials arranged for a tank truck with potable water to be parked at a restaurant in the middle of the affected block, and shower facilities were opened up and made available to the public at the public high school and middle school. Affected water pipes were flushed and then super-chlorinated.

The contamination occurred when a water main that was being repaired was broken inadvertently while a construction crew was widening a bridge. In the two hours that it took to repair the break, four pesticides used to kill termites, ticks, and other pests entered the water main through backsiphonage from the pesticide company. The pesticides consisted primarily of Dursban, with chlorodane, heptachlor, and lindane. In small diluted doses these chemicals are not harmful, but ingestion of moderate doses causes vomiting. Large doses cause breathing difficulties and may be life-threatening.

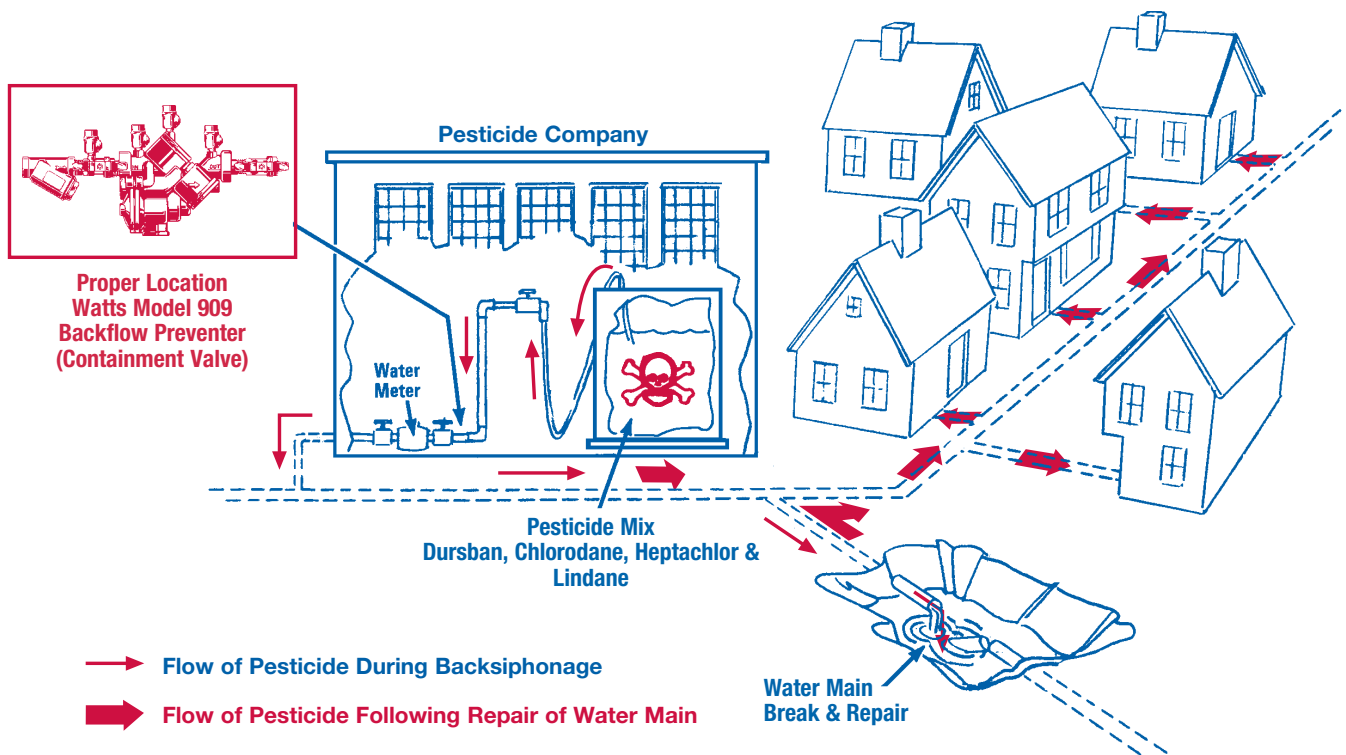

The cause of the contamination was determined to have been brought about by a combination of simultaneous events. A siphoning action occurred in the water pipes resulting from the water main break. Concurrently, a termite control company employee was rinsing a tank that contained a weak solution of heptachlor and chlorodane. The hose that he was using had Dursban on it and approximately one to three gallons of the pesticide chemicals were sucked into the potable water supply system.

The pest control company was ordered to cease and desist operations immediately following the incident when it was learned that they did not have a backflow prevention device in place. Following the installation of a backflow preventer, they were allowed to resume operations.

Because the contaminants would “cling” to the potable water supply piping, the plumbing in many of the homes was being considered for total replacement; the cost of which was alleged to be the responsibility of the pest control company. Cost estimates for plumbing replacement were being assessed together with the financial liability involved for replacement of a length of water main, new valves, and new service lines to the houses. Additional potential expenses accumulated as a result of the incident included the water supplied by the tanker trucks, water coolers provided to nine locations, overtime charges for employees, cost of materials to flush the lines with chlorine, and water testing charges. In addition, the pest control company could be liable for fines of up to \$3,000 per day for not having the backflow preventer in place.

Fortunately, there were no injuries! However, had a backflow preventer been initially installed on the main service line to the pest control company (a containment valve), the incident would not have occurred. The backflow preventer would have prevented the contaminants from back-siphoning into the main distribution system of the public water supply system and would have prevented the contamination of 63 adjacent homes.

A 21 million dollar law suit has been filed in federal court against the pesticide company by 21 homeowners. They claim that the pesticide company, who was held responsible for contamination, irreparably damaged plumbing fixtures, and the residents continue to suffer physical injury and have been subjected to mental distress, inconvenience, and loss of property.

---

This incident again emphasizes the need for public water supply companies to insist upon isolation of high hazard installations through the use of backflow prevention devices. Had the termite control company installed a reduced pressure principle device at the water meter (a containment device) the pesticide would not have back-siphoned into the water main and contaminated 63 homes. The use of fixture outlet protection backflow prevention devices on the hoses, spigots and hose bibbs within the termite control company building would have protected their own internal plumbing and assured the personal safety of their own employees.



**July 29, 1986**

At approximately 10 a.m. on July 29, 1986, an adult woman and two daughters, who were part of a Girl Scout Troop performing at a local fair in southwest Missouri, came to the first aid station presenting symptoms of vomiting and abdominal distress. After vomiting, the two girls' symptoms resolved almost immediately. Investigation by the Environmental Health team of the Springfield Greene County Health Department which was at the first aid station, determined that abdominal distress occurred within minutes of partially consuming a soft drink.

It was determined that the soft drink was fountain-dispensed. The food stand where the soft drink was purchased was temporarily closed. The owner agreed to a detailed examination of the dispensing machine.

Based upon the symptomology presented, it was suspected that a heavy metal poison was the primary cause. The possibility existed that a backflow preventer had failed somewhere within the system of mixing and dispensing lines. With the failing of the backflow preventer, the possibility existed that either cleanser or carbonated beverage had stayed in contact with metal surfaces the previous night, eroding metal ions that were incorporated into the drinks. Samples were drawn for atomic absorption analysis at the environmental health laboratory in Springfield.

An inspection of the equipment revealed a check valve in the carbonation line that prevents carbonated water from reverse flow into a copper tubing line which carries potable tap water which is then mixed with the syrup for finished product dispensing. Laboratory analysis, which were received at 2:30 p.m., revealed the "tap" potable water before entering the system had a copper level of .15 ppm, zinc of .7 ppm and chromium non-detectable. The suspected finished product tested 2.7 ppm copper, zinc 2.2 ppm, and chromium non-detectable.

Another flavor finished product tested 6.4 ppm copper, 3.8 ppm zinc, and chromium non-detectable. The suspected soft drink line, according to the manager, had been flushed prior to taking samples. However, the other line had not been flushed and was determined to be used only during peak periods of trade. Examination of the check-valve which allowed carbonated water to back into the copper line revealed a stuck spring, allowing for backflow siphonage.

Repair and flushing of the system was completed by 3:30 p.m. Laboratory analysis of the finished product after repair, completed by 4:30 p.m., revealed acceptable results for copper. The stand was re-opened for business at 5 p.m. The patients were strongly advised to seek medical evaluation but reported they were feeling "O.K." and proceeded to their next performance.

**February, 1988**  
**Letter To Major**  
**Soft Drink Vendors**  
**From Division Of**  
**Environmental Health**  
**State Of Minnesota**

Letter reads as follows:

We are writing to inform you of a current public health problem, and to request your cooperation and assistance in efforts to resolve the problem.

The Minnesota Department of Health has received numerous reports of illness associated with the ingestion of beverages from post-mix-type carbonated beverage dispensing machines. These illnesses have been demonstrated to be a result of carbon dioxide causing the leaching of copper from copper tubing, with resulting high concentrations of copper being ingested. Copper can be very toxic, with acute illness potential ranging from gastrointestinal tract irritations and vomiting to death.

A major factor contributing to the current problem is that carbonated beverage machines are normally supplied and installed only with a check valve or double check valve at the carbonator. For such machines, a check valve or double check is not adequate. To comply with the Minnesota Plumbing Code, an approved backflow preventer must be installed preceding the carbonator. The appropriate backflow preventer for this use is a double check valve type backflow preventer with intermediate atmospheric vent. It should be installed between the pump and the carbonator, and a unit which is specifically designed for installation on carbonated beverage machines is highly recommended to promote proper functioning and greater lifespan of the device. In addition, there should be no copper tubing in the system down line of the backflow preventer.

The Department is asking the manufacturers and distributors of carbonated beverage dispensing machines to supply them only with approved backflow preventers, and that the beverage companies inform their field personnel that all installations must be verified to have an approved backflow preventer, whether supplied with the equipment or added in the field.

Your cooperation in resolving this problem is greatly appreciated. If you have any questions, feel free to call Mr. Milton Bellin at 612/623-5517.

Sincerely yours,

Raymond W. Thron, Ph.D., P.E.  
Director, Division of Environmental Health



## March 9, 1988 Oil fouls water in city

as told by The Plain Dealer, Cleveland, Ohio

### Residents say they became sick

*"I took my blood pressure pills (with water) the other day. I swallowed it, that was enough for me."*

Resident, Edna Smith

**Diluted water-soluble oil, containing potentially toxic chemical additives, apparently backed from a Madison Ave. factory Friday into city waterlines and from there into the tap water of a half-dozen families on Pear Ave.**

Ernest Cedroni, city water commissioner, said all families on the affected section of Pear were notified on Sunday not to drink the water. But two families say they didn't find out there was a problem with their water until Monday, after one of the family members began vomiting.

Cedroni said city employees took samples of the water on Saturday after receiving complaints from residents of foul-smelling water. Cedroni said the official warning was issued as soon as the city determined by sight and smell that there might be a problem.

City employees did not learn the nature of the contamination until yesterday. Cedroni called the oil's additives nitro-butyl morpholine and ethyl-nitro trimethylene, but those names could not be independently verified late yesterday.

"This would be toxic, of course, if you took it in concentrated form," Cedroni said. "But," he said, "we have no idea at this time how concentrated it was when people were drinking it. I don't know if we'll ever find out."

The oil was tracked yesterday to Advance Manufacturing Co., 6800 Madison Ave., and the plant's water was then shut off.

Cedroni said the oil, used for cooling equipment, was mixed with water and kept in a tank at Advance Manufacturing. He said a valve apparently malfunctioned after the tank was pressurized, allowing the oil-water mixture to back into the city waterlines.

**"It wasn't negligence," he said. "It was just a case that they had something that wasn't (effective enough). All they had was a check valve."**

"I've got the whole plant disconnected ... until we can get some protective devices."

City officials investigating the problem with an official of the Ohio Environmental Protection Agency since Sunday, said **that the leak would not have happened if the factory had installed assemblies to prevent chemical backflow into the water.**

This preventable incident again illustrates the need for an effective cross-connection control program.

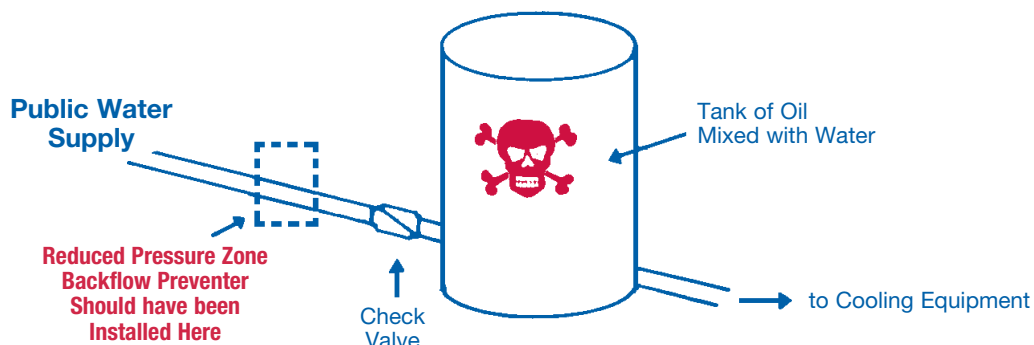

## January 7, 1989

### Theater Manager Averts Poisoning Tragedy

Garland Daily News

by Ken Turetzky Daily News Staff (Dallas, Texas)

A dozen children who attend a pair of Garland day-care centers suffered copper poisoning after drinking water and Cokes while attending a special show Dec. 31 at the Walnut Twin Theatre, investigators at the Garland Environmental Management Department said recently.

However, the officials said, all of the children recovered quickly. The quick work of theater manager Betty Christenson prevented more children from becoming ill, the officials added.

The children attend Treehouse Preschool at 602 Castle Glen and Treehouse North, 3317 Buckingham, both owned by Louis and Carol Coates of Garland. The incident has not disrupted either school, Ms. Coates said. "All of our kids are just fine," she said. "There's no problem."

The environmental department shut the theater down about 11 a.m. Dec. 31 and allowed it to reopen at 8 a.m. Jan. 2. Investigators said a malfunctioning soft drink mixer sent carbonated water into the theater's water lines and created the problem.

Children from four area day-care centers attended the show, environmental investigators said. However, 161 children from the Treehouse schools arrived first. Eight children from Treehouse Preschool and four from Treehouse North suffered severe vomiting and stomach cramps, Environmental Management Department Sanitarian Chuck Henry said.

"When I arrived about 10:50 a.m.," he said, "the water department had already flushed the lines and (Garland Fire Department) paramedics were treating the children."

Henry was able to obtain a water sample, although the lines had been flushed.

"They (Water Department crew members) responded very quickly," Henry said. "They were just doing what they were supposed to do." Technicians at the Dallas County Forensic Laboratory later confirmed the children suffered from copper poisoning.

"The amount of copper was one-third higher than the normal amount found in Coca-Cola," Environmental Management Director Pat Fowler said.

Technical Services Coordinator John Teel of the environmental department explained a backflow preventer on a mixing head attached to a soft drink tank had malfunctioned about 9 p.m. Dec. 30. Employees shut the soft drink tap off when the malfunction occurred, Teel said, but they did not realize the nature of the accident and began using the machine again the next day.

With the backflow preventer disabled, Teel added, carbonated water had settled overnight in the theater's water line and "leached" copper from the line.

"Copper salts were carried in the lines to the drinking fountain about 15 feet away and to the soft drink dispenser," Teel said. The first children to drink copper-laced water suffered the most severe cramps, Teel said.

But theater manager Betty Christenson acted quickly when children became ill, he said.

"When she saw the number of children vomiting, she refused to allow any other children to have anything to drink," he said.

"She physically removed the remaining soft drink containers from all of the other children," Fowler added. "It could have been a very bad situation."

"If (Ms. Christenson) hadn't been so calm," Teel said, "We would have been in trouble."

## Carbonated Beverage Incidents - Topeka, Kansas

Story as related to Watts Regulator Co. by  
Mr. Al Hermsen, Consultant to the Water Industry  
Topeka, Kansas - Tel. (913) 235-9994

There were a couple of related incidents that occurred here in Topeka that really point up the need for a careful assessment of every water outlet for cross-connection.

About two months ago, there was a complaint from a convenience store that they were experiencing air in their water. The complaint was that the air was messing up the coffee machine, causing too strong a brew, because not enough water was being metered into each batch.

An investigation revealed that, indeed, there was air in the water. Other outlets in the restrooms, etc., did have the usual blast of pressure from air in the system. However, no other stores in the same shopping center had reported similar conditions. Subsequent checks of the restrooms in those facilities did not reveal any air in the water.

So, back to the drawing board. Obviously the source of the air had to be from within the convenience store itself. The only connection that could cause a gas to enter the water was a fountain drink machine, the type that has a water connection.

If the gas that was entering the water was carbon dioxide, the Ph would have to be low. A grab sample was taken to the water lab. Our normal Ph as the water leaves the plant is around 8.4 The sample came in at 6.5, obviously proving the CO<sub>2</sub> was getting into the water.

The supplier was called and replaced the little check valve that is supposed to prevent this from happening.

In my opinion, the small check valve in the carbonator is not sufficient protection to prevent CO<sub>2</sub> from migrating back into the copper plumbing. Without a backflow preventer that can be tested on a regular basis, there is no way to predict its reliability. The small cost of a device on each drink machine at the point just downstream from the connection to copper would be a low cost insurance to protect the public health.

To continue without more backflow protection on fountain drink machines would be courting disaster. An approved dual check valve, tested annually, should give the protection needed at a very small cost.

Not too bad an incident, right? No one really hurt, just some bad coffee. Read on. This one was just plain lucky!

Some eight weeks or so later, the Health Department got a call reporting that a couple with a young daughter had stopped for refreshments at an ice cream store. The man had eaten an ice cream dish and the woman and girl both had a cola drink. Shortly after drinking the cola, both suffered severe stomach cramps and nausea. Since this was the only thing either had ingested, they were certain the cola had caused the symptoms.

The health officer suspected heavy metal poisoning from the symptoms and called me to check for a possible cross-connection. From the previous experience, I immediately suspected the fountain drink machine.

I again took a water sample to the water lab. This time the Ph was down to 5.5, so there was apparently a larger amount of CO<sub>2</sub> getting into the water. Also, an atomic absorption test revealed a large amount of copper in the sample.

Further discussions with the operators of the ice cream store revealed that the young man who opened the store at 10:00 a.m. had served himself a drink out of the machine at about 10:30. Apparently this was made from water that had spent the night in the plastic piping that formed the last four feet or so of the plumbing, because he didn't suffer any discomfort. Then, this drink must have been made with water that had become acid from CO<sub>2</sub> leaking back into the copper plumbing. This acidic water was aggressive enough to cause enough copper to go into solution to become toxic.

## Stop Backflow In Carbonated Beverage Equipment

### No. 9BD



Code officials:

Protect safe drinking water by inspecting all installations of carbonated beverage dispensing machines and equipment. Install a Watts No. 9BD backflow preventer for vending machine water supply lines in accordance with manufacturers installation instructions.

This most stringent protection of the safe drinking water is necessary to protect against backpressure backflow to prevent copper sulfate poisoning.

Be sure to follow all installation instructions and never allow a CO<sub>2</sub> tank and equipment to be installed in a closed vault/non-ventilated enclosure.

For further information send for ES-9.

Size:

3/8" F.C.T.

1/4" NPTM

3/8" NPTM

# THE DENVER POST

February 1, 1990

Voice of the Rocky Mountain Empire

Final Edition / 25 cents

## Antifreeze taints water at school Drinking fountains poison eight students

By Jim Kirksey  
Denver Post Staff Writer

Eight Brighton middle-school students were sent to the hospital yesterday after drinking antifreeze that had seeped into the water in the school's drinking fountains.

Overland Trail Middle School was closed after 11 a.m. yesterday, and it will remain closed today while authorities seek the source of the pollution.

Rodger Quist, principal of the 6-year-old school, said the ethylene glycol substance is used in the building's hot water heating system, which isn't supposed to be connected to the drinking water system at Overland Trail.

## January 1990 Fouled Water Closes School In Brighton

On Tuesday, January 30, 1990, according to the Rocky Mountain News, "authorities closed a Brighton middle school . . . after an anti-freeze like chemical was found to have leaked into the school's water." Nine Overland Middle School students were treated in an area medical center complaining of flu-like symptoms including vomiting, abdominal pain, and headache. They were released from the medical center after being treated for ethylene glycol poisoning. The school was closed for an additional day so that workers could repair the heating system leak that led to the apparent contamination, and to flush the water pipes in the building.

The contamination from backflow occurred because a valve designed to prevent anti-freeze from mixing with the school's drinking water was not installed. Another valve that would have stopped the backflow of anti-freeze was left open.

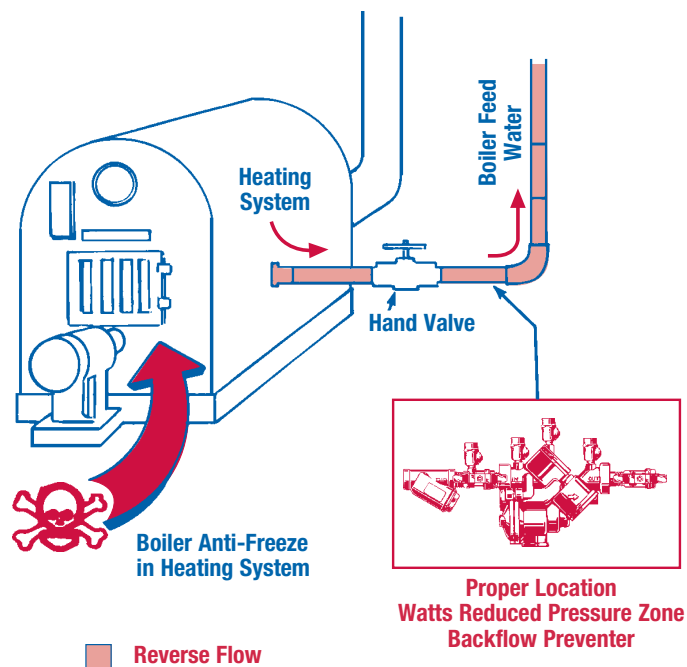

## December 14, 1990 Devices Not Protecting City's Water

By John Dempsey (State Writer)

**Brentwood** - City officials checking protective devices that safeguard Brentwood's drinking water from contamination have discovered that 51 of 71 devices tested so far failed to operate, city records show.

Additionally, the protective devices, known as backflow preventers, were missing at the Brentwood House Shopping Center and four of five Koger Center office buildings. The fifth Koger building was properly fitted with the protective device, city records show.

Backflow preventers protect public drinking water systems from contamination during periods of low water pressure.

Property owners have agreed to install the devices, which cost \$1,500-\$2,000 each, after the holidays, Codes Inspector Mark McMillen said.

Most of the devices failed due to poor maintenance, McMillen said. Owners are being required to fix or replace faulty backflow preventers, he added.

Ironically, Brentwood's government offices in the Municipal Center and two just-installed devices at the Maryland Farms Racquet and Country Club failed to operate when tested, city records show.

On Sept. 25, city officials began enforcing state and local laws that require the protective devices and prohibit the potentially hazardous practice of cross-connecting a building's plumbing to switch back and forth to a private source.

A month earlier, state health authorities discovered a cross-connection while investigating a summer-long outbreak of intestinal illnesses among 1,100 guests at the Maryland Farms Racquet and County Club.

State health investigators believe the guests consumed sewage-tainted wellwater the club substituted for properly treated Brentwood city water.

As a result, the City of Brentwood was cited Nov. 6, for violating the state's Safe Drinking Water Act.

 Nashville Banner

### Water gaffe nets club \$40,000 fine

By Jessica Pasley  
Banner Staff Writer

The Tennessee Department of Health and Environment fined Maryland Farms Racquet and Country Club \$40,000 Friday in connection with contaminated water linked to a rash of illnesses in August.

More than 200 people developed nausea and diarrhea during the weekend of Aug. 18-20 after drinking the well water the club was using.

The club offered to pay the medical bills of those who became ill after environmental testing showed the water was contaminated with fecal matter from sewage.

State officials said the sewage leaked into at least one of three wells used at the club before investigators recognized the problem and switched over to Brentwood's city water system on Aug. 20.

The facility had been using the well water, which they said was chemically treated, since 1986 to save on city water costs and to avoid water cutbacks in the event of a drought officials have said.

Ken Larish, general manager of the club, said although all repairs were done in August the club will "rely on municipal water exclusively from now on."

He said although they have settled most of the lawsuits filed because of the illnesses, some are still pending.

"It won't go away completely. It's been a slow, slow process."

Larish received the state order Friday requiring it meet three demands or face further penalties:

1) Maryland Farms officials most take immediate action to ensure that the club "connect and remain connected to the City of Brentwood water system for all water supplied at the Club except that to fill swimming pools and for irrigation."

2) They must provide proof from an engineer that no further cross-connections exist between the club and Brentwood's water system within 15 days.

3) Install backflow prevention devices in accordance

with the recommendations of a professional engineer within 30 days.

The state fined the club \$50,000, of which \$40,000 is to be paid within 30 days after receiving the order.

Furthermore, the club will be fined \$5,000 for requirements number two and three each if they are not completed in the times allotted.

Brentwood also faces a \$15,000 penalty from the state for "failing to adequately implement its cross-connection control plan," according to the order.

The order requires the city to conduct inspections of all identified cross-connection prevention devices in their service area on or before May 1.

It must also "conduct a cross-connection survey of its entire water system for the purpose of identifying additional potential cross-connection hazards, and submit a report of the survey findings" to the state on or before Dec. 1.

Brian J. Sweeney, the mayor of Brentwood, said he will be meeting with the city manager and city attorneys "to discuss if there is a just reason to appeal it".

"Mr (J.W.) Luna (Tennessee Health and Environment Department commissioner) feels it is a fair fine, and I respect their thinking, but if we feel it is justified to sit down with him to diminish the fine, we will do so," Sweeney said.

He said although he does not like the city being fined, because it is taxpayers' money, there are available funds.

"We have a 10 percent fund reserve for emergencies or projects we want to undertake that are not in the capital budget," he said.

He said if there is no reason to appeal, the city will work with the commission and pay the funds.

Meanwhile, Maryland Farms has lost 25 members due to the contaminated water, said Larish but there are still 1,400 members who "are quite supportive."



## METRO/STATE

Saturday, January 12, 1991

## City, Country Club Fined For Violating Safe Water Drinking Act

By John Dempsey (State Writer)

**Brentwood** - State health officials levied civil penalties against Maryland Farms Racquet and Country Club and the city of Brentwood yesterday for violating Tennessee's Safe Drinking Water Act.

Health Commissioner J.W. Luna fined the posh club \$40,000 for sometimes operating its own water treatment system for more than 19 months. An estimated 1,100 guests became ill after consuming sewage-tainted wellwater on several occasions last summer in what was described as the largest outbreak of its kind in the state's history.

Luna fined Brentwood \$5,000 for failing for more than two years to carry out its own program designed to adequately safeguard its public water supply. During that time, the city did not inspect any existing buildings for protective safety devices required by local and state laws to prevent contamination.

"The two cases are so closely related we wanted it to come out together," said David Draughon, director of the water supply division of the state's Department of Health and Environment.

In addition, the club must furnish a certified engineer's report within 15 days that no remaining plumbing cross-connections are located on the premises. Also, the city must inspect all known high-risk sites by June.

If either fails to carry through, each faces additional \$5,000 fines, Draughon said.

Ken Larish, the club's managing partner, declined comment yesterday on Luna's order, but said an appeal would be considered Monday.

Brentwood City Manager Michael Walker said he would withhold comment until the city had reviewed all its options.

Mayor Joe Sweeney said he would confer with Walker about an appeal, but said the city was committed to a revitalized cross-connection program.

Larish said club membership was down 8% to 1,417 full members since last August's outbreak of illness, although only 25 members resigned as a direct result of the problem, he said.

The club has paid more than \$70,000 in personal medical bills, he said.

In addition, civil rights lawsuits totaling more than \$1.5 million have been filed in connection with the incidents, which resulted in fewer than 10 persons hospitalized.

Maryland Farms installed its own treatment system in April 1987, but state investigators could only pinpoint actual drinking water consumption since 1989, Draughon said.

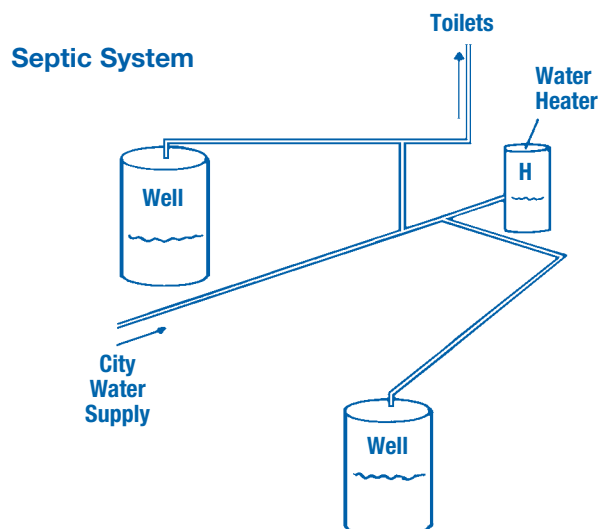

## METRO/STATE

Saturday, January 19, 1991

## Maryland Farms Partner indicted in water case

By John Dempsey and Jim East (Staff Reporters)

**Brentwood** - Ken Larish, managing partner of Maryland Farms office park, and Dick Evans, former manager of the park's exclusive country club, were arrested yesterday on indictments charging felony violations of safe drinking water laws.

The charges stemmed from the privately owned Maryland Farms Racquet and Country Club's use of an unapproved water source last summer to supply water that proved to be contaminated, causing intestinal illnesses among an estimated 1,100 club patrons.

Larish and Evans, accompanied by their attorneys, turned themselves in at Williamson County Jail and were briefly locked in a holding cell before being booked and released on \$2,000 cash bonds, officials said.

Williamson County grand jury returned sealed four-count indictments earlier this week against the pair. A Jan. 28 Circuit Court arraignment has been set for Larish and Evans, each indicted on one felony count and three misdemeanor counts involving the state's Safe Drinking Water Act. Maryland Farms Inc., the corporation that operates the club, also was indicted.

The felony is punishable by a maximum prison sentence of one to two years and fines of up to \$3,000 upon conviction. In addition, Larish and Evans could receive jail terms of up to 30 days each on the misdemeanor counts, said District Attorney General Joe Baugh.

An estimated 1,100 club patrons became violently ill for as long as three days after consuming sewage-tainted wellwater which the club had sometimes substituted for properly treated water from the city of Brentwood. Water from both sources were piped into and used by the club. About 10 people were hospitalized, said Jerry Narramore, a communicable disease official with the state's Department of Health and Environment.

State health authorities ended the outbreaks by hacksawing the club's water switching apparatus and dismantling its wellwater treatment system Aug. 21, Narramore said.

Larish, who is also general partner of the financially troubled Maryland Farms office park, declined comment on the case against him. "You hurt me enough," he told a reporter. Evans also declined comment.

Maryland Farms is negotiating with 13 banks on a five-year plan to pay off \$19 million in loans to avoid possible foreclosure, it was disclosed a week ago.

Maryland Farms Racquet and Country Club on Aug. 27 suspended Evans, after eight years as manager, in connection with the outbreak and notified him he was fired by hand-delivered letter one day before the Sept. 21 state health department show-cause hearing.

Last summer, some club members were outraged when they learned club staffers routinely filled distilled water bottles with wellwater to cut costs.

Baugh said his criminal investigation was conducted at the same time as the state's inquiry.

"We both received a resolution of it pretty much contemporaneously," Baugh said.

State Health Commissioner J.W. Luna on Jan. 11 levied a \$40,000 fine against the club for serving unapproved wellwater and fined Brentwood \$5,000 for failing to safeguard its public water supply.

State health investigators charged that Brentwood officials should have known the club switched water sources since monthly consumption sometimes dipped to 100 gallons, resulting in a billing of a minimum \$10.81 monthly charge.

Meanwhile, the city, when it realized in 1988 a revenue loss was occurring, began charging the club a flat monthly rate of \$1,356.40 for sewer services, city records show.

Brentwood City Manager Michael Walker said yesterday he was unaware of any ongoing criminal investigations of city employees. Baugh said he doubted that any Brentwood employees or officials would be indicted.

"I know that the Department of Health did assess civil penalties, but I don't think that the grand jury can indict a subdivision of the state," he said.

# Comprehensive Coverage

By Tony Arthur

(National Sales Manager Watts Regulator)

Maryland Farms Racquet and Country Club was fined \$40,000 on January 11, 1991. 1,100 members/guests became ill after consuming sewage-tainted wellwater on several occasions during the summer of 1990. The city of Brentwood, Tennessee, whose system also served the premises, was fined \$5,000 by the State Health Department for failing to safeguard the public water supply from the well.

The club has already paid \$70,000 in medical bills and faces civil lawsuits totaling more than \$1.5 million. Membership is down 8% to 1,417 full members. On January 18, 1991 Ken Larish, Managing partner of the club and Dick Evans, former Manager, were arrested on indictments charging felony violations of the State's safe drinking water laws.

At a November 6th, 1990 show cause hearing the city cited insufficient manpower and resources to conduct inspections of all existing buildings, concentrating on new construction only. The city was cited for failing to monitor any of the 69 premises considered possible sources of contamination.

In June of 1984, the club informed the city in writing that they had drilled an additional well, cross-connected the plumbing and could generate sufficient volume to supply all its needs. In August, the city responded by demanding installation of a backflow prevention assembly. Despite monthly fluctuations in the meter readings from 0 to 848,000 gallons during 1989, the city failed to follow up the request, and instead switched the club to flat rate billing. An assembly was not installed.

Most insurance policies include clauses which limit payments for damage from pollution due to the negligence or actions of the insured. As illustrated above, building owners and occupants need solutions to protect their health, as well as, their financial, moral and legal well being. A comprehensive program from the water purveyor to the occupant would have been far less costly than the situation faced by the participants in the Maryland Farms case.

What constitutes a comprehensive program? Comprehensive means defensible; involving survey, installation, inspection, testing and maintenance.

To establish the front line of defense, the internal plumbing system needs to be protected at each "point of use". Systems which tap off the plumbing system, such as mechanical, fire or irrigation lines need to be isolated. To accomplish this, a thorough survey by a trained backflow prevention specialist should be undertaken. The survey defines the fixtures and equipment requiring assemblies and what choice of assembly fits the degree of hazard. Survey courses are available through schools such as Treco or U.S.C.

The building owner can proceed with an informed plan of action by installing the assemblies called out in the survey process. It is important for the owner to contract with licensed and trained professionals who can protect health, understand the system hydraulics and save money by doing the job correctly. Installation criteria includes knowledge of local code requirements, proper clearances for service and testing, making allowance for water discharge, protection from freezing and the selection of quality name brand materials.

Inspection of the job is a critical component in the comprehensive coverage program. Documented inspections by a plumbing inspector, state or local health official and the water purveyor provide proof. Responsible actions, code compliance and good faith efforts were undertaken. Professional survey and installation work will minimize objections or changes.

To be truly defensible, a program must have a test and maintenance schedule. Local code water conditions, usage or the nature of the hazard will dictate the frequency of test. Not all devices are testable, but they should all be inspected annually, (for instance - devices on vending machines or lab faucets). Maintenance begins with a visual inspection noting the general condition of the device or assembly. The conditions the valve must operate under will dictate the frequency of service. High flow rates, harsh water conditions, high temperatures, water and other factors may shorten the valve's life expectancy.

Most codes require a complete replacement of all rubber parts in testable assemblies every five years. Because all systems undergo constant changes survey should be repeated periodically.

Moving outside the building, the water purveyor must treat his district the same way the building owner views his plumbing system. By following the same steps, the water purveyor creates a good defensible program:

1. Define the problem - **Survey**
2. Protect the public health - **Installation**
3. Document the program - **Inspection**
4. Provide integrity and - **Test**
5. Oversee the results - **Maintain**

Comprehensive coverage protects everyone.

Had the Health Officials of the City of Brentwood taken these prudent measures to ensure safe water protection for the community, this incident may not have occurred.

## JULY 1991

### Water Mix Up at Alameda Naval Base

By Yasmin Anwar

(Chronicle Staff Writer)

For eight months, firefighters at the Alameda Naval Air Station have been drinking water that may be contaminated because the Navy hooked them up to the wrong water supply, a firefighters' union official said yesterday.

A burst water main last week revealed that 70 firefighters have been drinking, cooking and bathing in sprinkler water meant for fire protection, said Captain Brook Beesley, president of the Local 259 of the International Association of Firefighters.

"People fixing the water-lines said to me, 'Oh my God, what do you want this for? This is undrinkable,'" Beesley said. "I'm getting sick to my stomach talking about it."

Since December, the non-potable water line has pumped an estimated 62,000 gallons to three trailers that have been used as temporary firefighter living quarters after the October 1989 earthquake destroyed the old firehouse.

Instead of connecting the fire-

fighters to an underground potable water source, the Navy hooked the trailers to the nearest hydrant, Beesley said.

The water is now being tested to determine the extent of toxic contamination and public health risks, Beesley said.

Navy officials could not be reached for comment.

Navy public works officials have meanwhile connected the firefighters to a potable water line.

Send for F-FPS, a 20 page brochure on fire sprinkler systems backflow prevention.

## MAY 1991

### State Plumbing Commission Report on Backsiphonage incident

On or about the week of the 14th of May, a backsiphonage problem was reported to Burnison Plumbing & Heating of Huron, SD. A local farmer, Mel Furher, called Burnison as to the problem on his farm.

Mr. Furher was filling a spray tank on his farm with water and 2-4-D. The wind kept blowing the fill hose away from the fill spout so he extended the hose down into the tank. As the tank filled, he went onto other duties. He went to the house for some reason and his wife told him that the water had become salty tasting. He immediately thought of the 2-4-D and went to the tank and it had began siphoning water from the tank.

He told his wife not to use any more water and called Burnison Plumbing & Heating. Burnison's went directly to the farm to try and ascertain what the problem was and to correct it.

What they found was an artesian well, (free flow) with which Mr. Furher was filling the tank. The artesian well also supplied water to the home through a storage tank and pump system. As the spray tank was filling, the pump in the house came on, and created a pull on the well greater than the pressure at the well head. Consequently, as the pump was on, it was also pulling the 2-4-D and water from the spray tank.

Burnison's installed a vacuum breaker on the hydrant feeding the spray tank and then started to contact State agencies.

They contacted the State Health Department, State Plumbing Commission, and Olsen Bio Chem Lab at the Animal Science Complex at S.D.S.U., Brookings. At the college, they talked to a Mr. Duayne Mathees. They told him what happened and that Amine 2-4-D was the chemical being used. Mr. Mathees informed them that Amine 2-4-D is a highly soluble chemical and a real

good flushing of the piping should correct the problem. However, Burnison's took a sample of the water and sent it to the State Lab for testing. In the mean time, the Furher's are using other water for drinking, cooking and bathing.

Mr. Furher was pleased with the plumber's response and procedure used. If the water sample comes back with a positive test, all water piping will be replaced on the farm and home. All hydrants will have vacuum breakers or any other backflow prevention that will be necessary.

*This report is respectfully submitted to the Commission by Glen LaFee, Inspector*

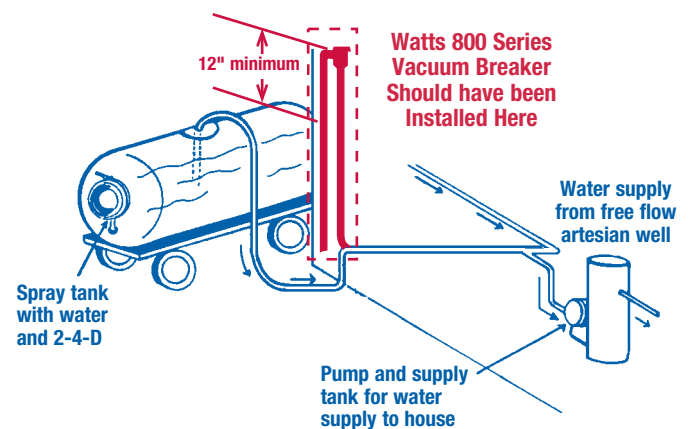



**September 22, 1991**

## **Bacteria Found in Town Supply - Norridgewock, Maine**

NORRIDGEWOCK (AP) - State Officials found fecal contaminants in the town's water supply Tuesday and ordered residents to boil water for drinking or cooking.

Households in the Norridgewock Water District must boil water for five minutes, said Jeff Jenks, program manager at the Department of Human Services' Bureau of Health.

"You can take a shower," Jenks said " just don't open your mouth".

Ellery Brown, water district superintendent, said the contaminated water is used by Norridgewock Central Grade School and the New Balance shoe company as well as private homes, offices, businesses and restaurants along Main Street.

The town's water supply comes from a well beside the Kennebec River, but officials hadn't immediately found the source of contamination.

"There's no such thing as a safe level of coliform bacteria," Jenks said.

He said the two types of bacteria found - Total Coliform and Fecal Coliform - are unsafe even in small amounts.

"Total coliform is not at all present in a properly operating public water system. Fecal coliform is very serious and potentially health threatening," he said.

Tests in six locations, which followed earlier hints of contamination, turned up contamination in five of the locations.

Brown said he immediately went to Norridgewock Town Manager Rodney Lynch on Tuesday morning to implement the emergency plan, which included shutting down school water fountains and ordering bottled water.

Water district officials were to add chlorine to the water supply Wednesday to kill the bacteria.

Brown said officials were tracking the source of the contaminants.

"I'm not going to point my finger at anyone for this one," Brown said, adding that public answers as to the source of the contaminant could still be days away.

## **Water contamination traced to restaurant**

*"There were a lot of doystems up there that didn't work and we're not sure why."*

Stephen McLaughlin, DEP engineer

• **A flawed septic system installed by the state is being blamed.**

Guy Gannett News Service

NORRIDGEWOCK - A Main Street restaurant with a failed septic system was ordered closed Thursday when studies revealed it to be the source of contamination of the town's water supply.

Big Al's Place, a nine-seat lunch counter, hardware store and game room, was condemned just before 2 p.m. by Norridgewock town officials.

Norridgewock Water District Superintendent Ellery Brown shut off the main water line to the building soon after. Al Lewis, 60 blamed state Department of Environmental Protection officials for the septic system that never worked.

"Every three months since they put this thing in I've had to flush backed-up sewage into the tank with a hose," Lewis said.

"I called them six months after they put in it five years ago and every year since then."

Town officials learned Tuesday morning of fecal coliform bacteria contamination in the town water supply from the state Department of Human Services. Residents were ordered to boil water for drinking, washing foods, feeding animals and brushing teeth.

Gary Geraway, a Department of Human Services engineer, said the order to boil water would be in effect until at least the middle of next week.

Meanwhile residents, school officials and businesses were adjusting Thursday to the third day of bottled water and a change in their daily food and hygiene needs routine.

Brown, Plumbing Inspector Mike Zarcone and John Dartnall of Thomaston, a water service consultant, said the Norridgewock problems are linked to at least three "cross-

connections" in the plumbing system at Big Al's Place located between Libby's AG store and York's Market on Main St.

A cross-connection, according to Dartnall, is the location of a pipe line which allows the drinking water supply to be connected to a line that contains a contaminant.

A classic example of cross-connected plumbing, which is the case at Big Al's Place, is a common garden hose attached to a water faucet on one end with the other end in a cess-pool.

The result is called "back-siphonage." According to literature supplied by Dartnall, backsiphonage can be created when there is a stoppage of the water supply during fire fighting or repair work to main water lines.

There was a fire just two doors down from Big Al's Place less than a week before the test.

Norridgewock Plumbing Inspector Zarcone agreed with Lewis about problems with the septic systems the state installed along Main Street beginning in 1980.

"The state put in a new system four or five years ago and it hasn't worked since," Zarcone said Thursday. He said the state told him "hands off" when it came to inspecting the new system.

"It was improperly installed from the start," he said. "They spent a quarter of a million dollars and they're all failing."

Stephen McLaughlin, a DEP engineer who helped coordinate the Norridgewock sewer project from 1980 to 1997, said the interior inspection of the new units was up to the local plumbing inspector.

"There were a lot of systems up there that didn't work and we're not sure why," said McLaughlin.



# Norridgewock copes with tainted water

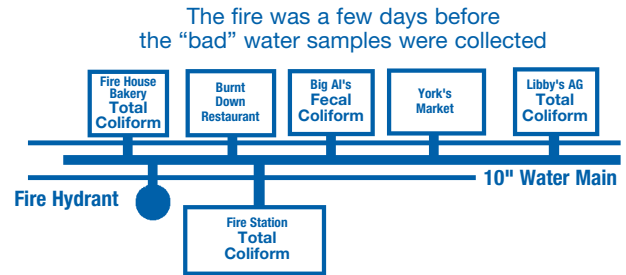
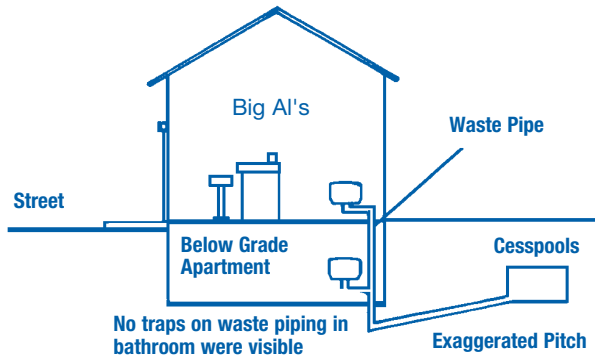

**By Doug Harlow  
Guy Gannett Service**

NORRIDGEWOCK - Residents, business owners and school officials were scrambling for clean water here Wednesday as the water emergency flowed into it's second day.

The elementary school kitchen staff used bleach, boiling water and disposable trays at lunchtime. Pots and pans were washed by hand in a special solution in the sink.

Student watercoolers in the corridors were closed and bottled bubblers were installed.

And according to Norridgewock officials, telephones were ringing off the hook with residents concerned over the presence of coliform and fecal bacteria discovered this week in the 500 unit district water supply.

A bed and breakfast establishment suspended food service Wednesday and a Main Street baker worked her craft amid buckets of steaming water.

Seven convenience stores on Norridgewock Water District lines were ordered to comply with state emergency regulations or be shut down by the Department of Agriculture.

Meanwhile, the first of two private engineering firms hired to tackle the water supply problem set up shop at the NWD pumping station.

Workers from Water Treatment Inc. of Yarmouth were expected to begin tapping the main line Wednesday afternoon for the first infusion of chlorine into the entire system.

Town Manager Rodney Lynch said the estimated \$2,000 cost of the chlorine pumping apparatus and the approximately \$70-a-day chlorination process would have to be picked up by the water district.

Norridgewock Water District Superintendent Ellery Brown said the chlorination process would eliminate the immediate threat to public health

by killing off the potentially dangerous bacteria.

But Brown cautioned residents and business owners that the chlorination process would take 48 hours to complete and that the state order to boil water would be in effect until further notice.

"I don't want people to think they can drink the water after 48 hours," said Brown. "They still have to boil water until the state gives us the green light."

Fecal and coliform bacteria were reported after a series of tests conducted by the state Department of Human Services in late August and early September.

Town officials were notified of the results Tuesday. Residents were then ordered to boil water for five minutes before drinking, washing food, feeding animals or brushing teeth.

According to Brown the next step will be to locate the source of the contamination.

As of late Wednesday, town officials would not speculate as to the origin of the contaminated water. The New Hampshire-based WSC Inc. is slated to begin work on the location process this morning, Brown said.

"It looks like we could be using chlorine forever," Brown said, noting that the once clean Norridgewock water supply had never been treated since the opening of the lines in 1954.

State Department of Agriculture inspector Mary Bryant said Wednesday that stores selling hot coffee and prepared sandwiches and other foods would have to sterilize and sanitize counter surfaces, utensils and other food preparation items to stay within the law.

"I told them what's going to happen if they don't comply," said Bryant. "This is very serious and I'm not being very nice today," she said. "They could all very well be shut down. I'm not going to fool around with this," she said.

## Series 909

**Reduced Pressure Zone Backflow Preventer**  
For high hazard cross-connections and continuous pressure applications

Designed to provide superior cross-connection control protection of the potable water supply in accordance with national plumbing codes and containment control for water utility authority requirements. This series can be utilized in a variety of installations, including high hazard cross-connections in plumbing systems or for containment at the service line entrance. With its exclusive, patented design incorporating the patented "air-in/water-out" principle it provides substantially improved relief valve discharge performance during the emergency conditions of combined backsiphonage and backpressure with both checks fouled. No. 9090T is standardly furnished with full port, resilient seated and bronze ball valve shutoffs. Sizes 3/4" and 1" (19, 25mm) shutoffs have tee handles.

Model 909 suitable for supply pressure up to 175 psi (12.1 bars) and water temperatures to 140°F (60°C) continuous and 180°F (82°C) intermittent.

For additional information, send for ES-909S.

Model 909QT-S

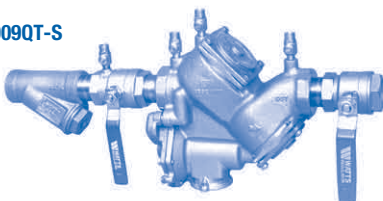

## Series 8

**Hose Connection Vacuum Breakers**  
For Backsiphonage Protection

Specially made for portable hoses attached to hose thread faucets. Their purpose is to prevent the flow of contaminated water back into the potable water supply. Device screws directly to sill cock. Can be used on a wide variety of installations, such as service sinks, swimming pools, developing tanks, laundry tubs, wash racks, dairy barns, marinas and general outside gardening uses 3/4" female hose thread inlet x 3/4" male hose thread outlet. Max. pressure: 125 psi. Max. temperature: 180°F.

No. 8A - Has exclusive "Non-Removable" feature and standardly equipped to allow sill cock to be drained.

For additional information, send for ES-8.



Model 8

Tested and certified under ASSE Std. 1011 and CSA Std. B64.2.

## Watts® Governor 80

**Ball Cock and Relief Valve**  
The answer to expansion problems

A triple purpose product: toilet tank ball cock fill valve, anti-siphon backflow preventer and thermal expansion relief valve in one assembly. Listed by IAPMO and CSA certified for anti-siphon ball cocks FDA approved, under CFR-21-177-2600. ANSI/ASSE No. 1002. It will govern and limit the domestic water system preset static pressure to 80 psi, as required by plumbing codes. Eliminates the need for thermal expansion tanks, auxiliary relief valves and their discharge lines.

Max. operation temperature: 110°F. Standard heights are 10", 11 1/2" or 12 1/2".

For additional information, send for F-80.



"Watts Governor 80"



**October 9, 1991**

## **Unwanted Guests - Residents find parasites in tap water - Heritage Newspapers/The News Herald**

**by Carol Baldwin**  
Staff Writer

SOUTHGATE - Parasitological worms were found in the water at two homes on Netherwood last week after a malfunctioning lawn sprinkler coupled with a watermain break sucked the nematodes into the water system.

The nematodes first showed up the evening of Oct. 1 after the backflow prevention system on the privately owned underground sprinkler malfunctioned.

Stan Jarski, the City's Department of Public Services (DPS) director, said Monday that water samples taken since then have been tested by both Detroit and Wyandotte's water departments and have come back negative for bacteria and are safe. "We got good clean samples from Detroit and Wyandotte," he said. "The Wayne County Health Department determined that an atmospheric vacuum breaker had malfunctioned and was in the open position. We had a water main break, and that caused a vacuum in the system."

When the water pressure dropped, the vacuum in the system sucked some water from the sprinkler into the city water, but was only distributed to two homes, according to Jarski.

He said DPS crews purged the water system and blew out hydrants for three blocks north and south of Netherwood to eliminate the nematodes.

Homeowner Jerry Blick found the worms swimming around in his bathtub when he started filling the tub for his child. He said he was appalled to find the critters, as well as rust and other debris, in his water.

"This happened Tuesday and I was still getting living things in the water Wednesday night," Blick said. "It's disgusting. If these have always been in the lines, then how come no one's ever seen them before?"

"The only reason I noticed it is because I have children and was giving my kid a bath. If you have a screen on your faucet or you were taking a shower, you wouldn't see it."

Jarski explained that the nematodes never would have found their way into the water if the sprinkler's backflow mechanism had worked properly.

He said the contractor who installed the sprinkler system didn't pull a city permit and used a "cheap" atmospheric vacuum breaker, and when it malfunctioned, which was at the time of the water main break, the nematodes were pulled right in.

"You can get a cheaper price, but it can cost you in the long run," Jarski said.

He said the resident who owns the sprinkler would be cited by the county for improper installation.

"This is nothing the system did," Jarski said. "We can monitor pressure and chlorine, but we're limited."

Blick said he tested the water for chlorine, and there was none in it when the nematodes first showed up.

Jarski said a pool tester will not pick-up traces of chlorine in tap water. He said the DPS tested for chlorine on Netherwood and two blocks away and it was a "perfect situation."

Blick said he thinks the city is trying to "candy coat" the problem and he's not buying the scenario presented by the DPS. He wants the water main replaced.

Jarski said the problem shouldn't happen again if residents have their sprinkler systems checked by professionals.

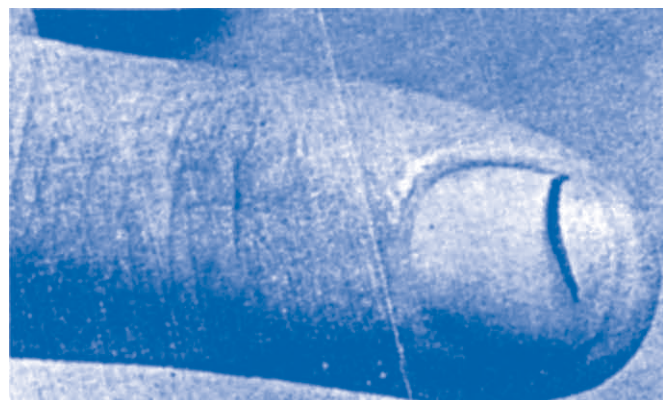
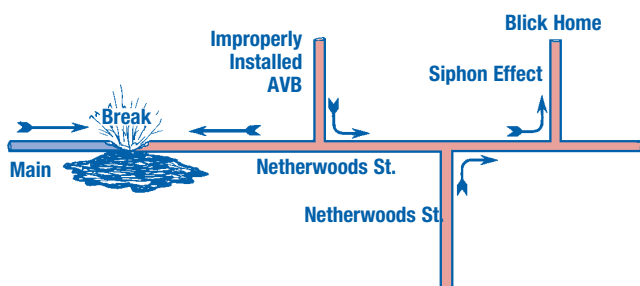

## Editorial Note:

As it sometimes occurs the whole story does not always make its way into print. We felt it was important to clarify some of the newspaper article's points. The AVBs were installed in violation of the local codes, which require a minimum of a PVB (800 series). Furthermore, the installer did not follow the recommended installation procedures. The AVBs were installed on their sides, they were piped with continuous supply pressure and had control valves downstream.

This installation caused the seat disc to stick in the open position to the seat and applied backpressure to the valve. This irrigation system was ultimately left with only an expensive elbow.

Local codes should always be checked for valve selection and the proper installation criteria followed (see below). Fortunately, although shaken, the Blicks were reassured by further tests that revealed that the species of nematode was not indeed a parasite.

## **GUIDELINES FOR BACKFLOW PREVENTERS FOR IRRIGATION SYSTEMS**

### ***AVB... Atmospheric Vacuum Breaker Watts Series 188A***

- One AVB required for each irrigation zone; no (on/off valves) allowed downstream of the AVB.
- Each AVB must be installed a minimum of six inches (6") above the highest point of water in the zone it protects.
- No chemical or fertilizer can be introduced into an irrigation system protected with AVB's.
- No pumps or sources for backpressure on downstream side of an AVB.
- Anti-siphon, single zone.
- Can only be pressurized a maximum of a 12 hour period out of 24 hours.

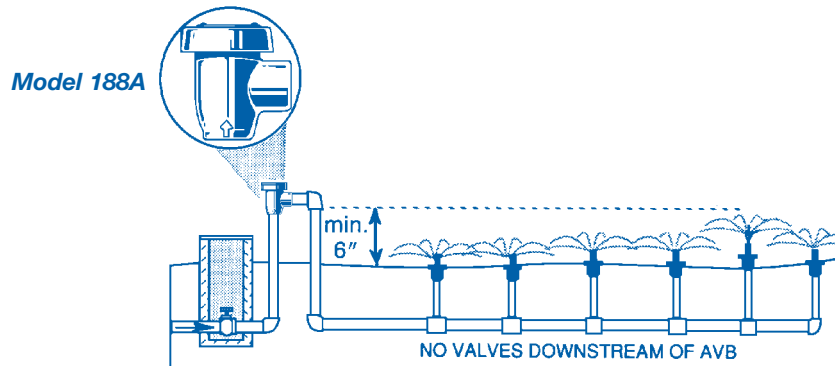

### ***PVB... Pressure Vacuum Breaker Watts Series 800***

- Only one PVB required to protect the whole system; (on/off valves) can be located downstream of the PVB.
- PVBs must be installed a minimum of (12") above the highest point of water in the sprinkler system.
- PVBs must be tested by a State-certified Backflow Assembly Tester ... when installed ... annually or when moved/repaired.
- No chemical or fertilizer can be introduced into an irrigation system protected with PVBs.
- No pumps or sources for backpressure on downstream side of (after) a PVB.
- Anti-siphon, multi-zone.
- Can be pressurized a full 24 hours.

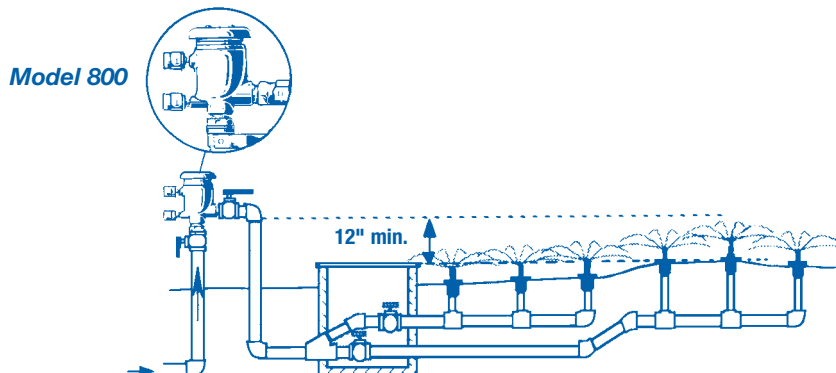

Spring 1991

## National Water Magazine Article - Chicken House Cross-Connection

By Jeff Stone

In response to a complaint from a customer on the Casa Water System (Perry County), a staff member of the Division of Engineering found that the water system had been contaminated by backflow from chicken houses. The chicken houses had been receiving water from the Casa system and also had an auxiliary well connected to the chicken house plumbing. The water system connected to the chicken houses included two single check valves in series for backflow prevention purposes. The water was being used to administer an antibiotic solution to the chickens.

During the weekend of June 23 residents in the area served by the water main became concerned when the water became noticeably discolored.

When made aware of the problem, the water system manager shut off water service to the chicken houses and flushed the water line extension serving the area. The water meter serving the chicken houses was later removed until proper backflow prevention could be assured. An inspection was made by a staff member of the Division on June 25 and water samples were collected for possible analysis. Unfortunately chemists determined there was not an accepted methodology for the particular antibiotic in the water.

The presence of the antibiotic in the water could have caused severe effects in humans who were hypersensitive to the drug. Due to these and other concerns, the Plumbing Division of the Department of Health considers chicken and brooder houses to be high hazards to the water system and requires proper installation of a reduce pressure zone backflow preventer (RPZ). In Casa, the area plumbing inspector is working with the owner of the chicken houses in order to install an RPZ backflow preventer before the water system again provides service.

There are at least 12,000 chicken houses in Arkansas according to the Cooperative Extension Service, and it can be assumed that most if not all of these houses administer a variety of necessary chemicals to their stock. Water system managers should make an effort to verify that if service is provided to chicken brooder or feeder operations, that an RPZ backflow preventer is properly installed.

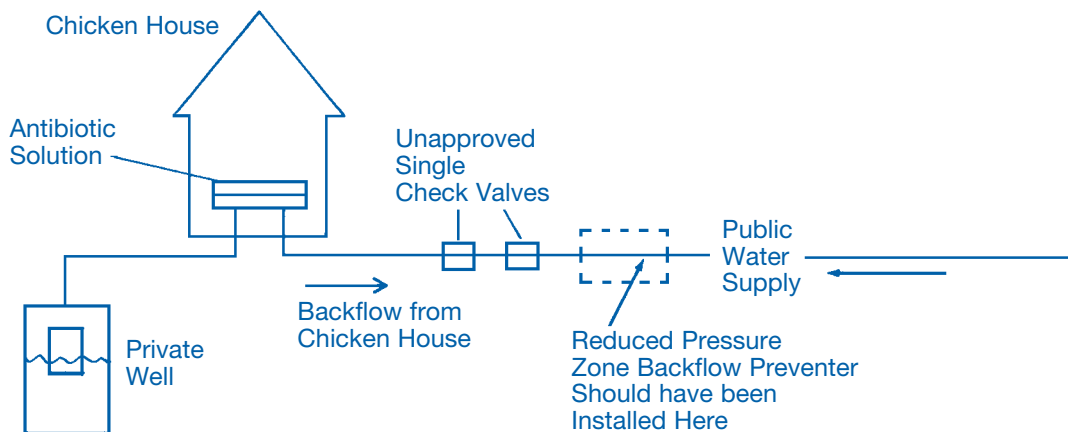

**Feb. 6, 1992**

## **Near Backflow Disaster Averted by Alert Maintenance Crew**

**By Dick Clary**

### **The Georgia Operator**

“Due to the responsible and quick action of Mr. Calloway and Mr. Randy Rice inevitable disaster was avoided.”

On Thursday, February 6, 1992, during the annual one-week club shutdown, an assistant manager of the prestigious Ansley Golf Club reported to Mr. Ron Calloway, Building Superintendent, that the water from the men’s grill bar sink was burning peoples hands as if it contained acid.

Mr. Calloway observed the brownish tainted water at the downstairs bar sink, and cautioned everyone from using any water while he checked the upstairs plumbing. He found tainted water in the rest of the building.

Next, Mr. Calloway contacted the Atlanta Water Bureau to determine if any water main repairs were being made in the area. It was verified there were none.

Mr. Calloway then called the Ron Watts Plumbing company for advice. Mr. Scott McEwen advised that a cross-connection was the most likely cause of the contamination, and cautioned them to turn off the building water supply immediately.

Mr. Ron Watts called the Atlanta Plumbing Department and the Water Bureau and requested an inspector from each as soon as possible. While waiting for these officials to arrive, samples of the tainted water were drawn from several points in the building.

Mr. Frank Smith of the Plumbing Inspection department and Mr. Roddy White of the Water Bureau arrived promptly, performed ph tests, and found the tainted water to have a ph level of 10. This represented an extremely high alkalinity or caustic level in the water.

Flushing the clubhouse water piping (copper tubing) was begun immediately and continued until Monday morning, February 10, when ph levels dropped to normal. The system was maintained in a static condition for 24 hours, and the ph levels remained at a range acceptable to the water bureau. The contamination had been alleviated.

In tracking down the source of the contamination, Mr. Calloway called the hood cleaning contractor who had just completed a cleaning operation on their kitchen hood. The contractor utilized a cleaning solution delivered by a high pressure washer to remove grease accumulation on the hood.

The cleaning solutions were placed in a tank and mixed with the water supplied by a garden hose from a hose bibb. The tank with the solution was then pressurized by an air compressor to 90-100 pounds per square inch (psi), while maintaining a continuous “water supply” in the tank. The water system pressure however was, only 55-60 psi. Thus part of the solution was backpressured into the potable water system.

The hood-cleaning contractor stated they used no acid in their cleaning

mixture and, upon request, provided the formula. It contained xanthum gum, sodium hydroxide, and isopropyl alcohol. The high pressure washer included no backflow-prevention device, nor did the club’s hose bibb supplying water to the equipment, even though the cleaning equipment operated at 90-100 psi while directly connected to the building system with a pressure of only 55-60 psi.

During the following week an independent lab tested the tainted water samples from the club and cross-referenced them by infrared curves with the hood-cleaning contractor’s formula, and found the curves to be a very close match.

Mr. Frank Smith, Atlanta Plumbing Inspector, returned to conduct a thorough cross-connection-control compliance survey. Ansley Golf Club then had all the required prevention devices permitted, installed, tested, and certified.

Due to the responsible and quick action of Mr. Calloway and Mr. Randy Rice, general manager, inevitable disaster was avoided. Had this incident occurred during any other week of the year, the outcome could have resulted in much pain and suffering.

This account of the incident was provided by Mr. Scot A. McEwen, President of Backflow Engineering Group, Inc., formerly General Manager of Ron Watts Plumbing, Inc.

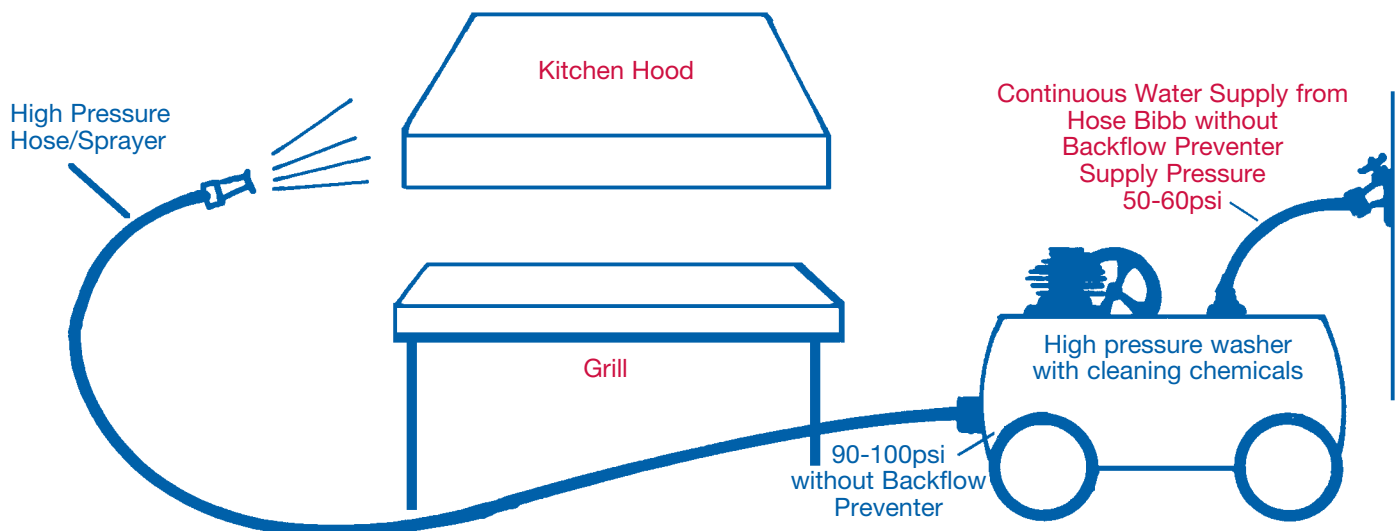



**Sunday March 15, 1992**

**The Oak Ridger, Oak Ridge, Tennessee - DOE workers ordered to stay away from water**

**By Paul Sloca** - Oak Ridger Staff

Oak Ridge may be a long way from Mexico, but Friday the message "Don't drink the water," could be seen and heard throughout the Federal Building.

Department of Energy officials discovered Thursday evening that workers installing a new boiler system got their pipes crossed, causing a backwash of boiler water to wash into the drinking water system.

A statement from DOE, explained that a faulty valve may have been the cause of the mishap.

DOE officials determined that up to 30 gallons of boiler water entered the drinking water system.

Because of the concern that the boiler water contained the contaminant sodium nitrate, measures were taken to prevent DOE employees from drinking water in the facility.

Signs warning of the problem were posted at water fountains, in bathrooms and other water sources in the building. Food cooked in the water was discarded.

Various facilities were set up, providing workers with bottled water.

Water tests confirmed Friday that sodium nitrate was not in the water. However, further tests were being conducted to check for other chemicals in the drinking water.

DOE spokeswoman Danielle Jones said an investigation was underway to determine why the valve malfunctioned and to find a way to prevent such occurrences from happening again.

In a written statement to media personnel, DOE stated employees have been advised to see the staff nurse or their personal physician if they are concerned. Also, DOE stated employees would be notified of the additional sampling results as soon as possible.

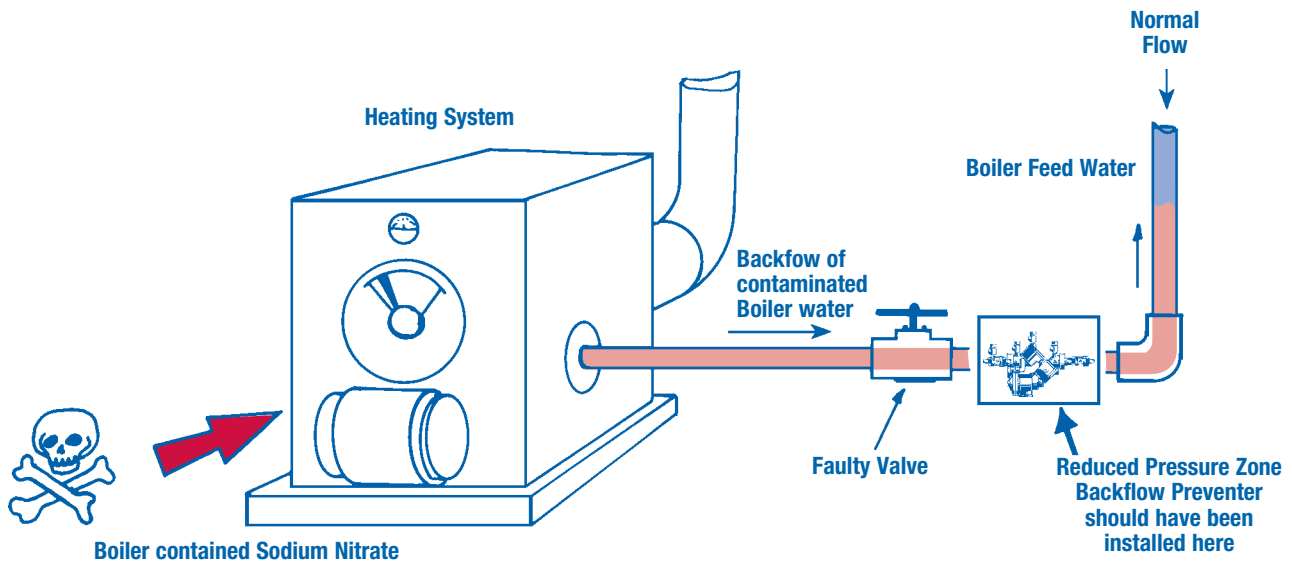

Friday October 23, 1992

## New Jersey - Pupils' sickness is traced to water - Clifton school's boiler blamed

By Seamus McGraw  
Record Staff Writer

Nadine Grieco isn't sure when - or even if - she'll send her 6-year-old daughter, Jessica, back to her first-grade class at St. Philip the Apostle School in Clifton.

But if Jessica recovered from severe food poisoning, does return, Grieco said, it will be with this bit of motherly advice: "Don't drink the water."

Local health officials seem to agree with that advice. They said Thursday night that they would reverse a position they took six hours earlier and recommend that the school continue to use bottled water for drinking and cooking.

The announcement came as officials disclosed that the school's drinking water was behind Tuesday's outbreak of methemoglobinemia, a potentially fatal form of chemical food poisoning that felled Jessica and 32 other first-, second-, and third-graders at the school.

Clifton Health Officer Stuart Palfreyman said chemically contaminated water from the boiler somehow got mixed with the school's drinking water. The water, containing a high concentration of the chemicals sodium metaborate and sodium nitrite, was used in a batch of canned and powdered soup served to all of the children who became ill.

Nitrites are believed to have triggered the sickness, which robs

the blood of its ability to carry oxygen and sent dozens of youngsters to area hospitals suffering from blue fingers and lips, nausea, headaches, and dizziness.

Officials initially concluded that something in the chicken noodle soup served in the school cafeteria Tuesday was to blame for the illness. Samples of the soup, a mixture of canned Campbell's chicken noodle soup and a soup extender made by Lipton, indicated a high concentration of nitrites, a chemical often used in small quantities as a food preservative.

But representatives from both Campbell Soup Co. and Thomas J. Lipton Co. said they use no nitrites in the manufacture of their soups. That was confirmed by tests conducted on sample cans and packages taken from the supermarket at which school employees had purchased the soup, Palfreyman said.

That left one ingredient: the water, he said.

Tests found that a chemical manufactured in Texas and comprising both sodium metaborate and sodium nitrite was present both in the school's boiler and in the soup.

Health officials are still trying to determine precisely how the chemical, usually used to stem pipe corrosion in hot-water heating systems, got into the potable water supply. Bernard Edelman, a spokesman for the

state Department of Health, said it is believed that a mechanical problem may have allowed water from the heating system to mix with drinking water.

"Presumably, the potable water was contaminated by a backflow from the boiler system," Edelman said. "They identified some plumbing deficiencies that could have allowed that to happen."

Palfreyman said inspections are continuing at the parochial elementary school, and he expects to meet with school officials today to discuss modifications of its plumbing system that could prevent a recurrence. School officials could not be reached Thursday for comment.

Until the school makes adjustments to its plumbing system there remains a possibility - a slight possibility, Palfreyman said - that the chemical contamination could happen again.

Water tests conducted at the school Thursday morning indicated that the water was safe, Palfreyman said. He and the Passaic Valley Water Commission, which provides service to the school, determined that it was safe to drink, and Palfreyman said he ordered the water turned back on about noon.

But he changed his mind after a handful of parents attended his news conference Thursday and questioned the decision.

"I'm going to recommend that they use bottled water for drinking," Palfreyman said, adding that he remains convinced that risk of a second incident remains small. "But we want to consider their concerns," he said.

Those concerns run deep. Grieco, whose daughter was among the most severely afflicted of the children stricken Tuesday, said she remained shaken by the incident and concerned about the possibility of it's happening again.

"I don't feel comfortable with it," she said of the Health Department's claim that it has solved the mysterious outbreak.

Jessica had consumed two bowls of the soup before falling ill Tuesday. She collapsed unconscious in school and had to be carried to an ambulance by a police officer.

The girl was transferred from St. Mary's Hospital in Passaic to a pediatric intensive care unit in Jersey City after physicians determined that she had more than 16 times the normal nitrite count in her bloodstream. Like all of the children, she was treated with methylene blue, a dye commonly used to mark organs during medical procedures. All of the children were released by Wednesday.

Update: A Watts 909-QT was installed before the bypass.

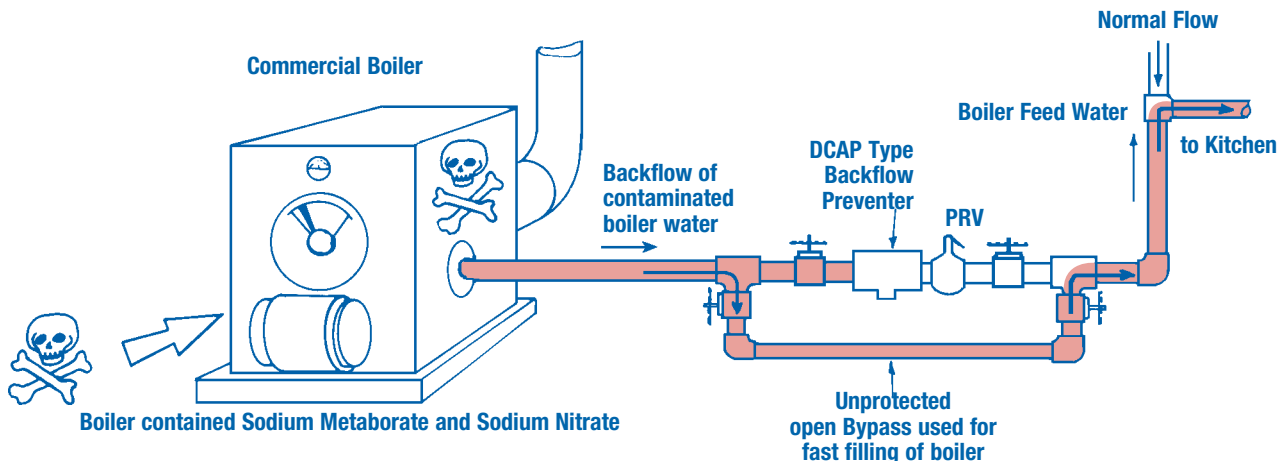

Boiler contained Sodium Metaborate and Sodium Nitrate

Unprotected open Bypass used for fast filling of boiler

**September 10, 1993**

## **Arizona Department of Environmental Quality - Boyce Thompson Arboretum Backflow Incident**

**By Tim Rowe - Southern Regional Office**

The Boyce Thompson Arboretum is a day use Arizona State Park located approximately 10 miles west of Superior, Arizona on U.S. 60. An estimated average of 300 people per day visit this facility.

### **The Potable Water System**

The Arboretum purchases all of its water from the Arizona Water Company. The water flows from a high pressure transmission line into the top of an elevated 2000 gallon storage tank. It first passes through a water meter located near the transmission line, and then a float valve and a pressure reduction valve. The pressure reduction valve discharges at a level lower than the level at which the storage tank overflows, so a true air gap does not exist at this location.

### **The Fire Suppression Systems**

Three residential fire suppression systems were installed in the Arboretum Visitor's Center in 1988. Each of the fire suppression systems were reported to have been filled with a 30% propylene glycol/70% water antifreeze solution to provide freeze protection down to 20°F. Each fire suppression system was constructed of "black" pipe, which is not approved for potable water use. None of the three fire suppression systems were equipped with backflow prevention devices.

A single 1" spring loaded, soft-seated, check valve, was installed vertically between each of the three fire suppression systems and the potable water system distribution system to prevent backflow.

The Arboretum contracted with a Fire Sprinkler contractor to conduct periodic preventative maintenance inspections of the fire suppression systems.

The last such inspection occurred on February 2, 1993. The antifreeze concentrations in each of the three systems were found to be insufficient to provide the desired level of freeze protection. Four sprinkler heads had been painted over and were replaced. Each of the three fire suppression systems were refilled with fresh propylene glycol antifreeze solution on April 20, 1993.

### **Incident**

On August 11th, 1993, a certified backflow prevention device tester called the Southern Regional Office (SRO) of ADEQ (Arizona Department of Environmental Quality) and reported that backflow from a fire suppression system was discovered at a state park near Superior, after people reported taste and odor problems.

SRO contacted the Arizona Water Company and asked if they might know anything about this report. They indicated they did not, and had not received any taste and odor complaints.

SRO then contacted the Boyce Thompson Arboretum about this report. The Managing Director immediately confirmed that backflow from one of the fire suppression systems to the potable water system had occurred

at this facility, and indicated that they had just discovered this the day before.

He reported that the Arboretum began receiving taste and odor complaints from their employees about the water in the Visitor's Center sometime in June, 1993. The water had an unusual odor which was variously described as, "garlicky, oniony, sweet, like rotten eggs" and combination of these terms.

During the ADEQ inspection of the public water system at the Arboretum on July 8th, 1993, the inspector was not informed of the taste and odor problems the Arboretum had been experiencing, or that the Arboretum possessed fire suppression systems. Unaware of the on-site fire protection systems, the inspector did not request to see the Arboretum's backflow prevention plan.

The taste and odor problems appeared to be the worst in the main restrooms in the lobby of the Visitor Center and at the drinking fountain which is just outside the restrooms. The drinking fountain and the fire suppression system are connected to the "dead end" line within a few feet of each other.

The same unpleasant tastes and odors were also noted in some of the administrative areas of the Visitor Center Complex. The other two fire suppression systems are located near these areas.

Several Arboretum employees reported nausea and intestinal upsets after drinking this water in late July or early August. The Arboretum posted a "Do Not Drink" sign on the drinking fountain in the lobby of the Visitor Center, and brought in a bottled water cooler/dispenser for use by the public and its employees.

Believing that the problems might be due to the presence of sulfur-reducing bacteria, the Arboretum began a program of strong chlorinations followed by flushings.

The Arboretum then began searching for other potential causes, and noted that the static pressure within the fire suppression system protecting the restrooms and drinking fountain in the lobby of the Visitor Center was close to the average pressure in the potable water system. The static pressure within the other two fire suppressions systems were much higher than the average pressure in the potable water system.

The Arboretum consulted with a contractor about the taste and odor problems, and reported the low pressure in the one fire suppression system. The contractors visited the site, and informed the Arboretum that there was little chance that the check valve was leaking, and it was more likely that the pressure gauge for this fire suppression system was broken or inaccurate.

The Arboretum also sought advice from an engineering firm which designed the Visitor's Center. The engineering firm advised them that the low pressure in the one fire suppression system could be the symptom of a very serious backflow problem.

The Arboretum removed the suspected pressure gauge from the fire suppression system on Tuesday, August 10th, 1993, and noted that the base of the gauge, where it had come into contact with the antifreeze solution, had the same unpleasant odor as that noted in the drinking water.

The Arboretum personnel tested the gauge. They found that this gauge was in close agreement with another gauge at both low and high pressures.

The Arboretum contacted the contractor with their findings, and demanded the problem be fixed. They reached an agreement to replace the leaking check valve with a reduced pressure principal (RP) backflow prevention device as soon as possible, and to replace the other two check valves with reduced pressure principal backflow prevention devices in several months when additional funds became available.

The Managing Director agreed to cooperate as much as possible. After becoming aware of the possible threats to public health that a backflow incident could produce, and not knowing exactly what chemicals were used in the antifreeze solution, he also decided to install the other two RP backflow prevention devices as well.

SRO (Southern Regional Office) contacted the Arizona Water Company - Superior public water system and informed them that the backflow incident had occurred at the Boyce Thompson Arboretum, so that they could check their service connection. SRO then collected the materials necessary to collect samples from the fire suppression system and from the potable water distribution system immediately downstream of the failed check valve and drove to the Arboretum.

Upon arrival, SRO found the contractor already on the scene and the installation of all three of the RP backflow prevention devices nearly complete. They had already removed the leaking check valve and a length of pipe from the fire suppression system protecting the restrooms and drinking fountain in the lobby of the Visitor's Center. This had drained both the fire suppression system and that section of the potable water system immediately adjacent to the failing check valve, so no upstream and downstream samples could be collected. An RP backflow prevention device had been installed where the failing check valve had been located.

SRO was supplied with a copy of a 1987 MSDS for propylene glycol. This MSDS stated that no adverse effects are anticipated if propylene glycol is swallowed, and that it is non-corrosive in nature.

The MSDS for propylene glycol indicates that it is odorless.

SRO observed a 5 gallon plastic container in the room where the failing check valve had been located. The label on this bucket indicated that it contained a 3% concentrate of an Aqueous Film Forming Foam (AFFF), and this product had been shipped to the original Fire Sprinkler contractor. The label did not list any chemical names or concentrations.

SRO, the contractor, and the Arboretum's certified operator, then disassembled the failed check valve.

Foreign material was found in the check valve.

The MSDS for the AFFF foaming agent indicated that it contains 25% Ethanol, 2-(2-butoxyethoxy) - C.A.S. No. 12-3345, which is a toxic chemical subject to SARA Title III reporting requirements, and other components. The MSDS indicates this product is toxic when ingested in either acute or chronic dosages, and recommends that a physician or Poison Control Center be called if swallowed.

The Managing Director stated that the contractor had indicated that this product had not been used in the Arboretum's fire suppression system and that this product is used in other types of fire suppression systems which they service, however, and theorized that an empty AFFF container may have been used to transport the propylene glycol, which the contractor buys in bulk, to the Arboretum.

He delivered a sample of the liquid in the AFFF container to SRO on Friday, August 13th, 1993. This liquid was clear, did not produce any foaming or sudsing when mixed with water, and initially was odorless. The MSDS for AFFF indicates that it is amber in color, and its purpose is to produce foaming. It is unknown if the AFFF container contained any AFFF residue, when it was filled with propylene glycol, however.

After approximately 10 days, this liquid began to produce an odor very similar to that detected in the water at the Arboretum. Propylene glycol is chemically similar to alcohol and sugar, and has the formula  $C_3H_8O_2$ . Microorganisms may be able to use this material as a source of nutrients, and the unpleasant odors may have been released by microbiological activity. If this is the case, it would explain why increase chlorination at the Arboretum helped reduce the taste and odor complaints.

Following the installation of the RP backflow prevention devices and flushing of the system, the Arboretum has reported that all taste and odor problems have been eliminated.

It was noted that "black iron" fittings were used on the potable water side. SRO (Southern Regional Office) informed the Arboretum of this problem and the Arboretum agreed to have these fittings replaced with galvanized fittings as soon as possible.

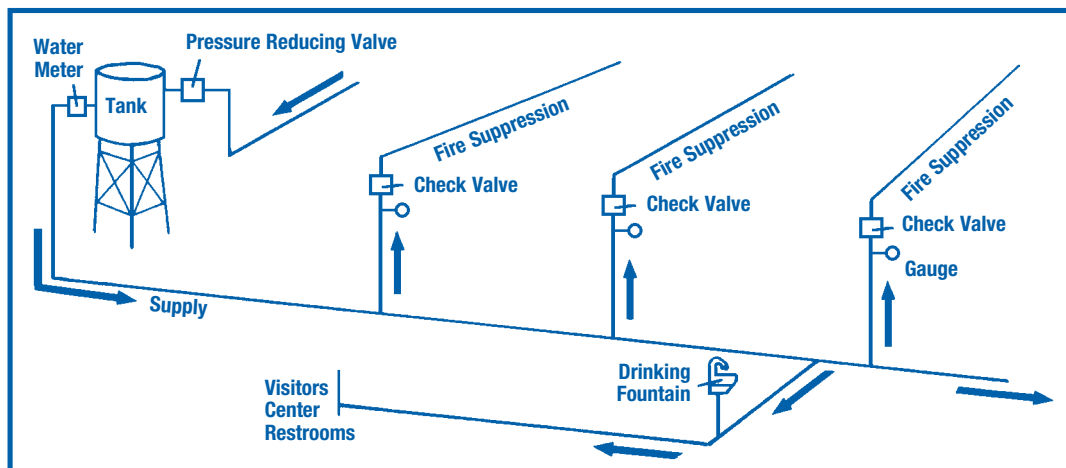

**March 1, 1994**

## **Boiler contaminates water at high school**

**By Charlotte Lowe  
Tucson Citizen**

When discolored water showed up at Palo Verde High School just before lunch yesterday, officials decided to send students home while the source of the contamination was checked out.

The school's 1,400 students were dismissed at noon, 2½ hours early, when pinkish water was discovered in a drinking fountain on a varsity softball field, said Marcie Luna, spokeswoman for the school district.

It was taken as a precaution, Luna said, while the school's engineer tracked the source of the contamination to a boiler system.

Some water used in heating apparently became mixed with a small portion of the school's drinking water, she said.

As it turned out, the contamination was restricted to the athletic field and none of the drinking water inside the school

at 1302 S. Avenida Vega was contaminated.

And the contamination did not affect water off the campus, she said. "Water has been shut off at the playground site and will remain shut off until the extent of the problem can be conclusively determined."

Classes were scheduled to resume today.

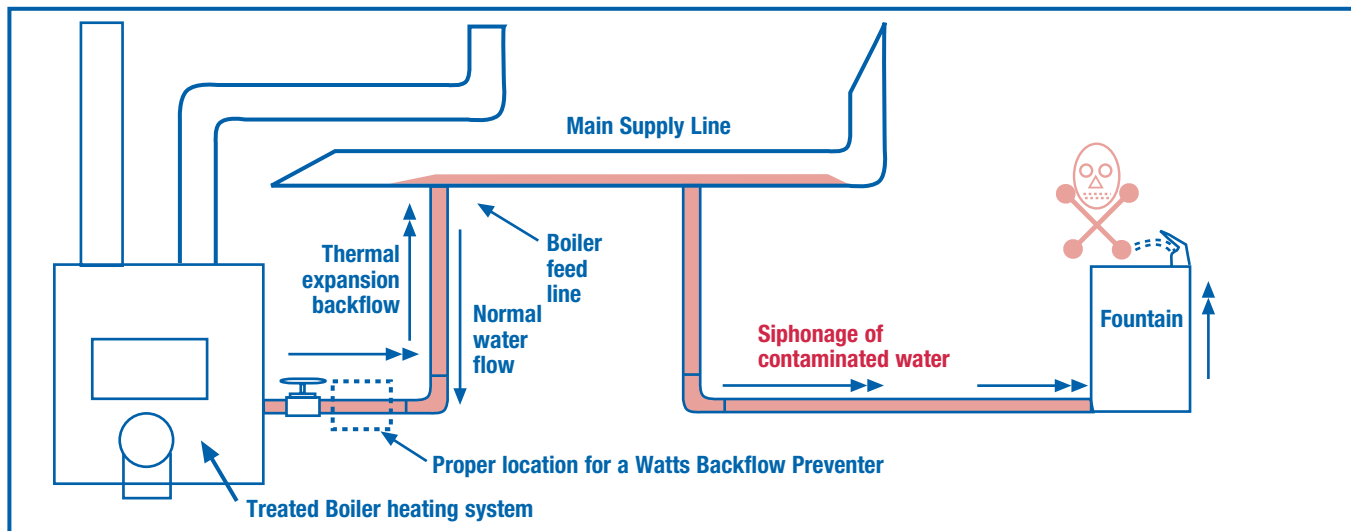



**September 3, 1997**

## **Chemical Leak Taints City Water - Charlotte Observer, North Carolina**

Schools, homes, and businesses in the Charlotte - Mecklenburg area were without potable water due to backflow contamination of the municipal water supply. Residents were warned not to use tap water for drinking, cooking or washing; chemical contamination could cause moderate-to-severe digestive distress and irritate the skin and eyes. "Poisoning the water - I see that as much worse than a hurricane," observes Tom McMeekan, a resident of the Steele Creek neighborhood.

The accident occurred when 30 to 60 gallons of a fire suppressant known as AFFF was introduced into the water supply. Contaminated water backed up into a hydrant through a fire hose used to flush a tank containing the chemical. The incident happened after a routine fire training exercise at the Charlotte/Douglas International Airport, officials said. Backflow occurs when pressure in the municipal system drops lower than in a connecting source - in this case, a fire hose.

After the incident, fire fighters began opening water hydrants in an attempt to flush the chemical from water lines. Later, city utility workers were notified, but the extent of the contamination wasn't determined until approximately four hours later. Then, crews opened hydrants in a broader area and began closing valves in an attempt to isolate potentially tainted water.

As crews hit the streets, some took water samples and the city's communications office alerted the media to inform residents. Doug Bean, Charlotte -Mecklenburg Utilities Director, said that water samples from several points in the area were sent to a Saint Paul, Minnesota, laboratory overnight for testing; in the meantime, officials have instituted emergency measures at 29 area schools. These procedures included use of bottled water only, the shutting down of drinking fountains, and providing sandwiches for school meals.

Restaurants were affected by the water problem which made dish washing impossible, and ice machines had to be emptied and thoroughly disinfected. Michael Palkovic, a local restaurateur estimates that several thousand dollars in sales were lost. "I hate not being able to serve my customers," he said.

Also, although crews continued to flush the mains, officials worried about the possibility of contaminations in some dead-end lines, which were to be flushed throughout the night. Once the advisory was lifted, officials cautioned, residents should run their hot-water taps for ten minutes, then their cold water taps for ten minutes. Environmental damage was a possibility too. County environmental officers, noted that any outflow could present potential damage to wildlife.

AFFF is biodegradable in sunlight, but if it ends up in creeks or streams, it can strip oxygen from the water and hurt fish and other aquatic creatures. Environmental protection enforcers said that the foam killed about 2,000 fish in Long Pond after its use in a truck roll over last spring.

Ironically, The Charlotte City Council recognized the potential danger from backflow, and in 1991, passed an ordinance requiring that all industrial, commercial, and irrigation customers to install backflow prevention devices. The Utility Department included information on backflow prevention in water bills, and is preparing a video on the subject.

The Charlotte Fire Department was not equipped with backflow prevention devices. Fire Department Captain Mark Basnight plans an investigation to determine how the incident happened and what changes can be made to stop any future occurrences. However, Utilities Director Bean notes, "All industries that use chemicals are required to install backflow preventers on their water lines. That would prevent spills like this. An industry that violated that regulation would be subject to a fine. It's too early to tell whether the Charlotte Fire Department violated that regulation, but a thorough inquiry will be initiated."

"We will certainly work with the fire department to ensure that when fire hoses are used, particularly with hazardous chemicals, that backflow preventers are in place."

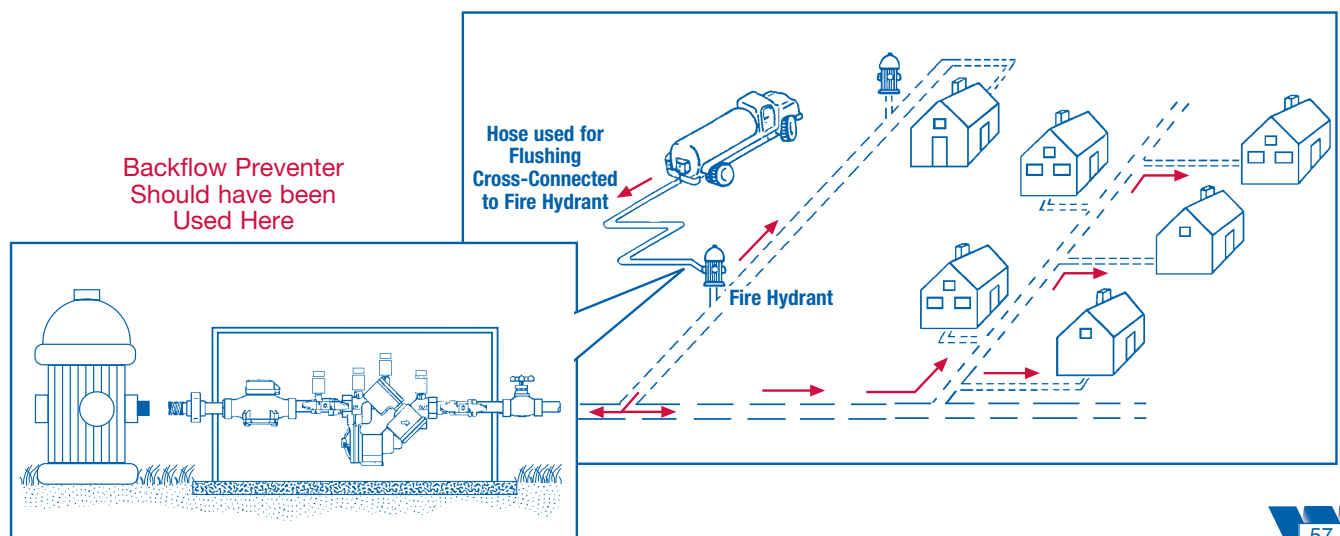

For additional information, visit our web site at: [www.watts.com](http://www.watts.com)



*A Watts Water Technologies Company*



**USA:** No. Andover, MA • Tel: (978) 688-1811 • Fax: (978) 794-1848 • [www.watts.com](http://www.watts.com)  
**Canada:** Burlington, ON • Tel: (905) 332-4090 • Fax: (905) 332-7068 • [www.wattscanada.ca](http://www.wattscanada.ca)